

SPECIFICATION

868MHz ISM Band Dipole Antenna

- Part No. : **OMB.868.B05F21**
- Product Name : 5dBi 868MHz ISM Band Indoor/Outdoor
Omni-Directional Antenna
- Feature : Suitable to use in robust outdoor environment
Dimensions: Height 1093.5mm
RoHS compliant



1. Introduction

The 868MHz Barracuda ISM Outdoor antenna is designed to have a long distance coverage. Omni-directional high gain across all bands ensures constant reception and transmission. The UV resistant coating with fiberglass housing makes this antenna suitable to be mounted in robust outdoor environment, pole-mounting and wall-mounting bracket is included.

The antenna finds its usage in metering, industrial monitoring and security applications.

This antenna is suitable to use as part of narrow channel M2M Sigfox Network, for simple M2M management in cities. The main applications would be Smart Cities, Utilities, Public Transport.

Specification

ELECTRICAL	
Standard	ISM 868
Band	860~870MHz
Antenna Type	Collinear
Gain(max)	5dBi
Polarization	Vertical
Impedance	50 ohms
Max Input Power	50 watts
VSWR	<1.5:1
Radiation	Omni-Directional
Vertical Beam-width	38 Deg
Horizontal Beam-width	360 Deg
Antenna Design	Dipole Array
Internal Material	Copper
Connector	N Type Female
MECHANICAL	
Length	1094mm(Max)
Base Diameter	70*55mm(Max)
Antenna Weight(G.W)	680g
Mounting Accessories(G.W)	70g
Application	Indoor/Outdoor
Radome Material	White Fiberglass
Base Material	Aluminum
Mount Style	Pole Mount/Wall Mount
Mounting	Stainless Steel
Wind Resistance	>150mph(>241km/h)
Housing	Fiberglass
ENVIRONMENTAL	
Storage Temperature	-20°C to +80°C
Operating Temperature	-20°C to +60°C
Operating Humidity	10%~80% non-condensing
Storage Humidity	5%~80% non-condensing

2. Antenna Characteristics

3.1 Return Loss

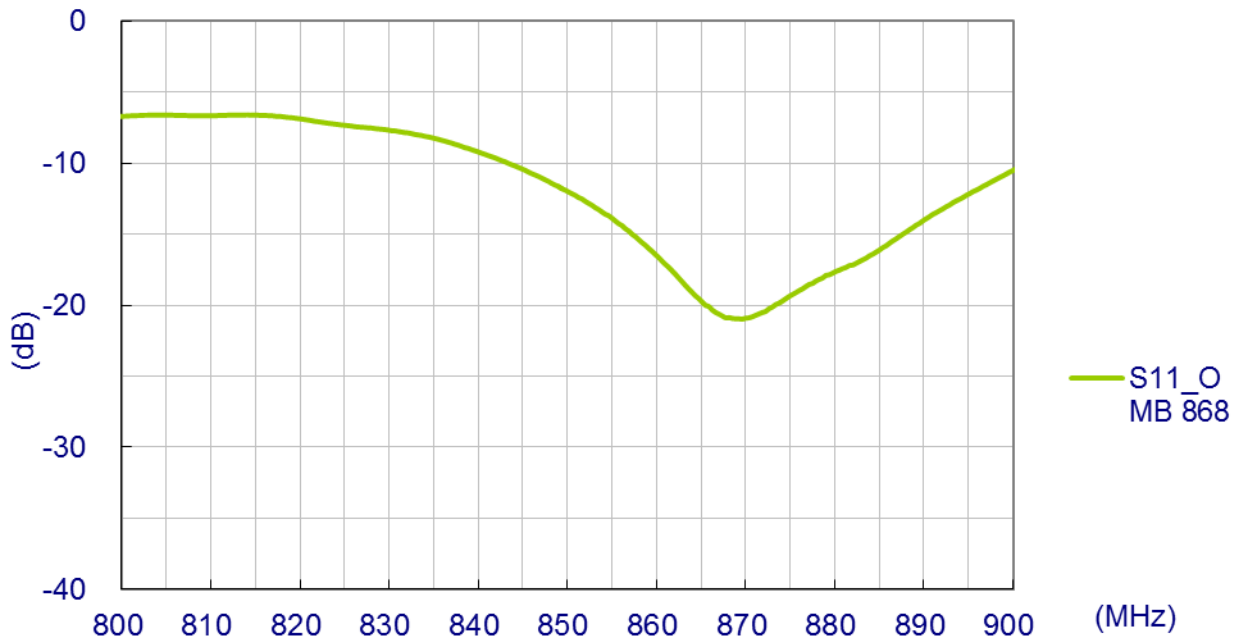

3.2 Maximum Gain

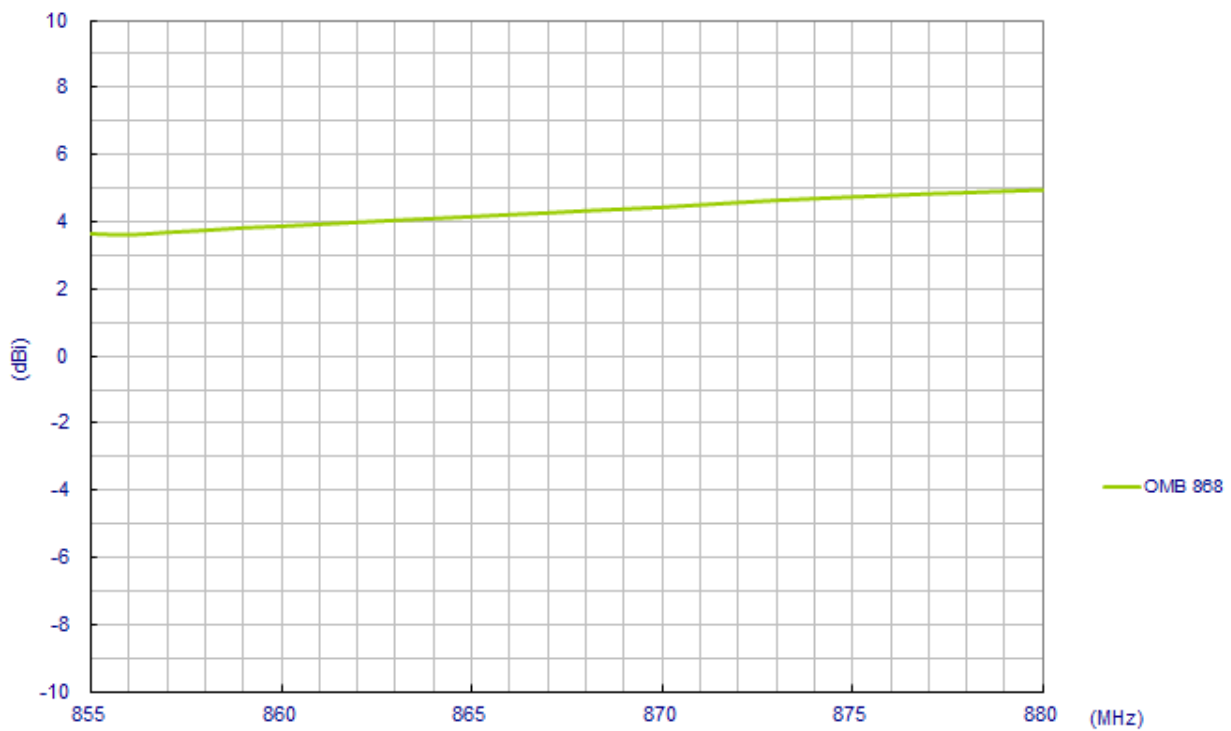

3.3 Average Gain

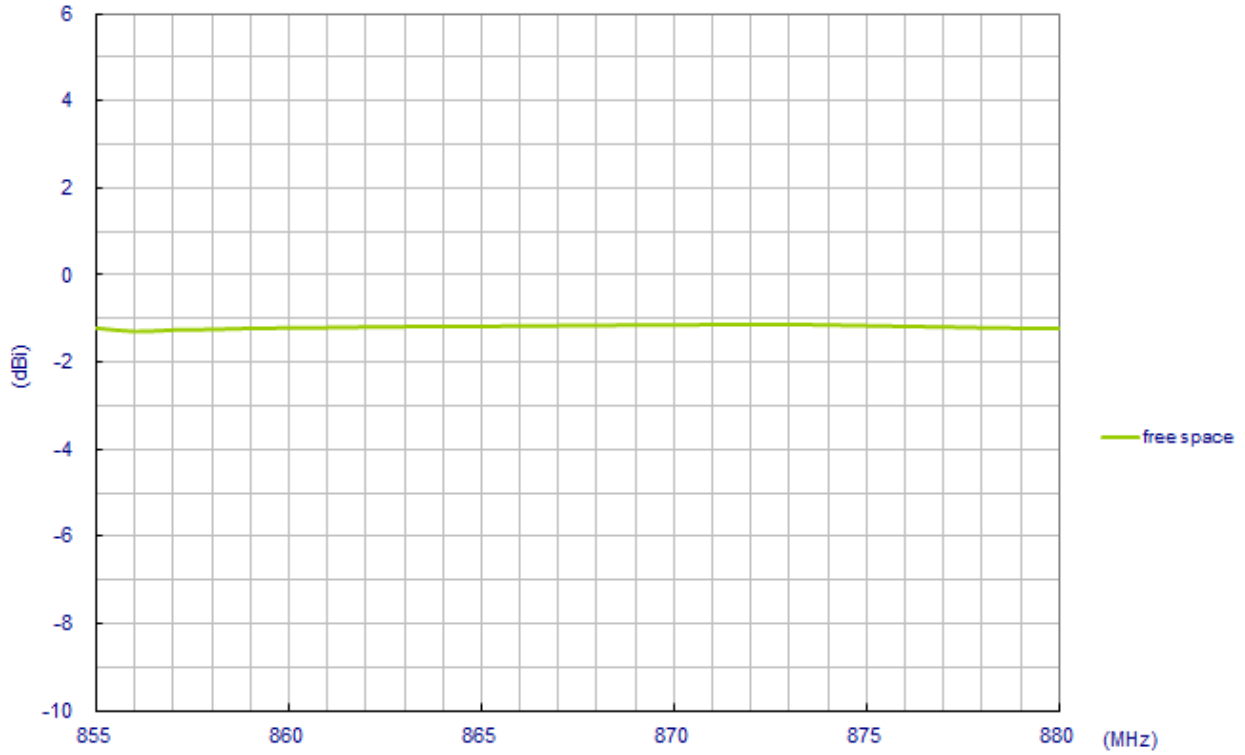

3.4 Efficiency

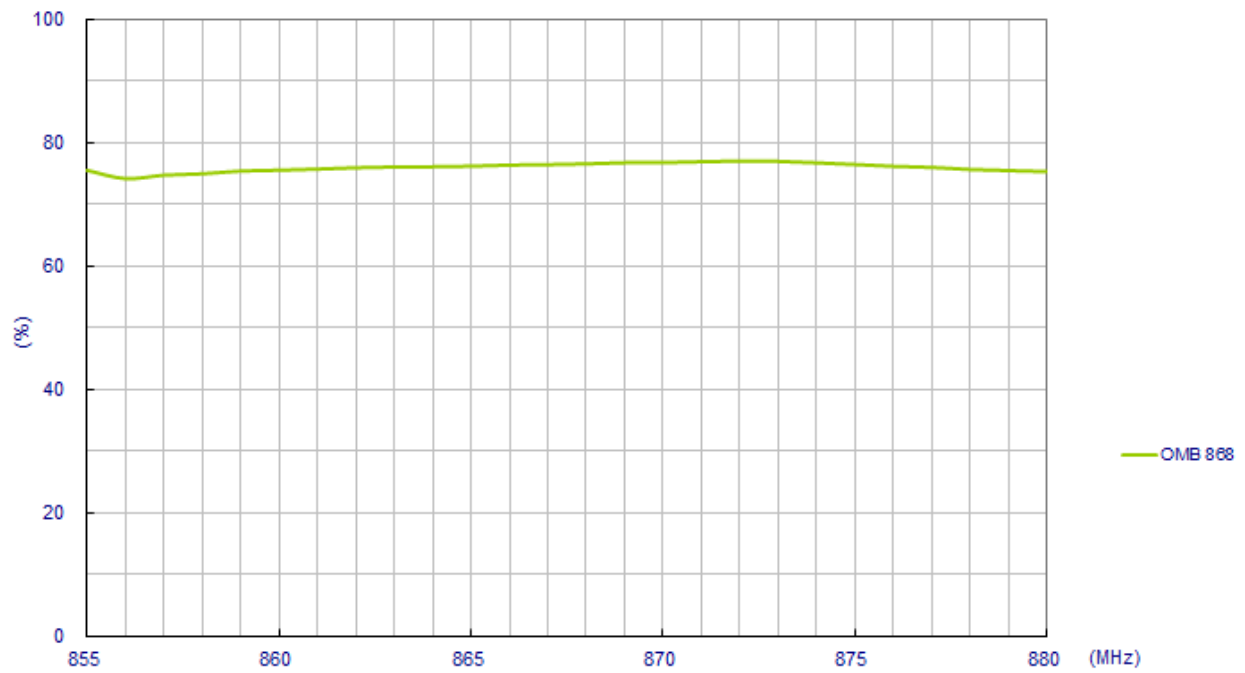

3.3D Radiation Property

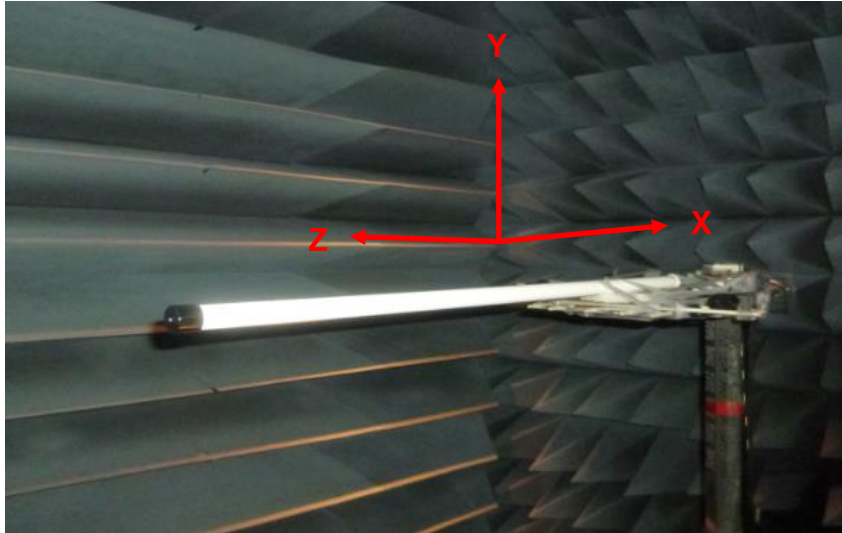

XY plane

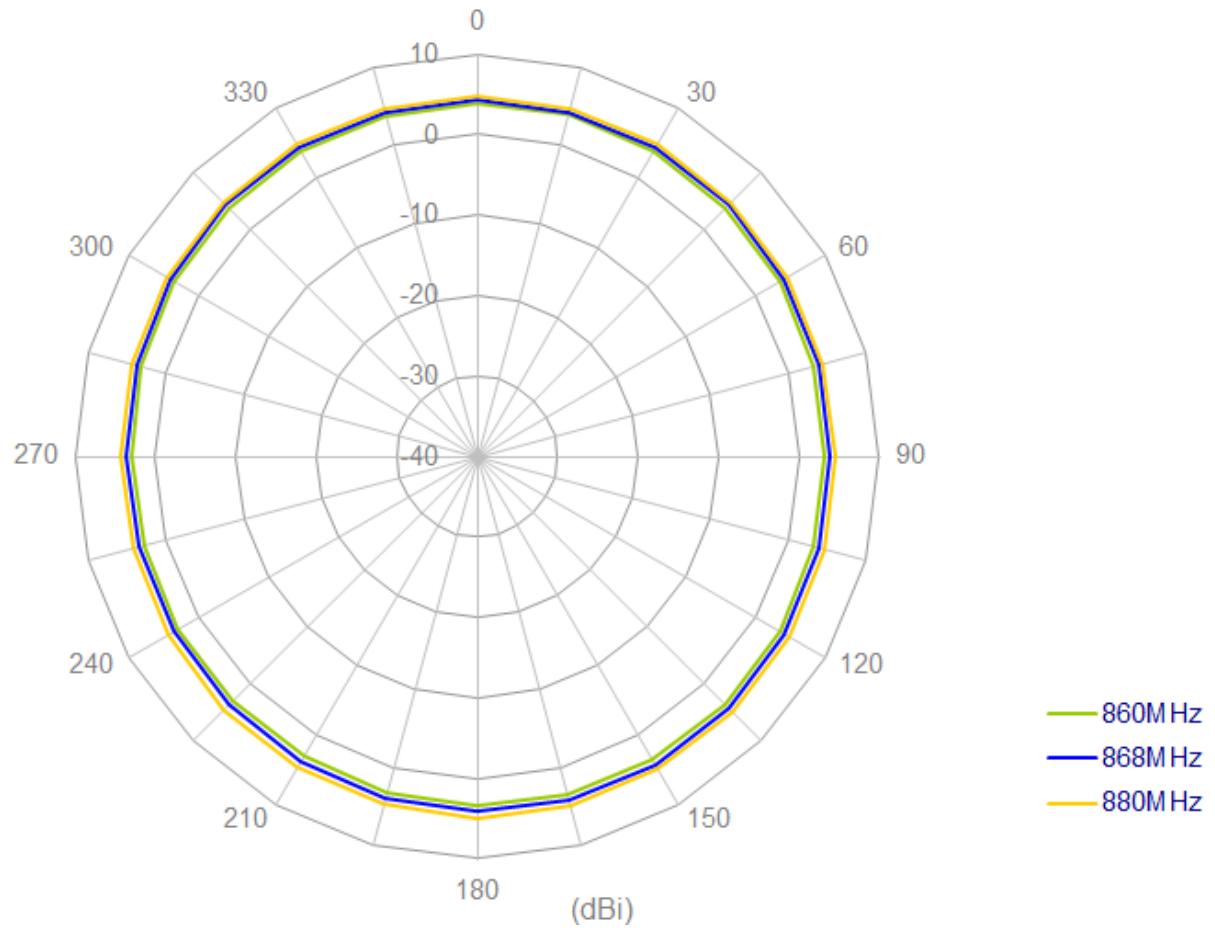

XZ plane

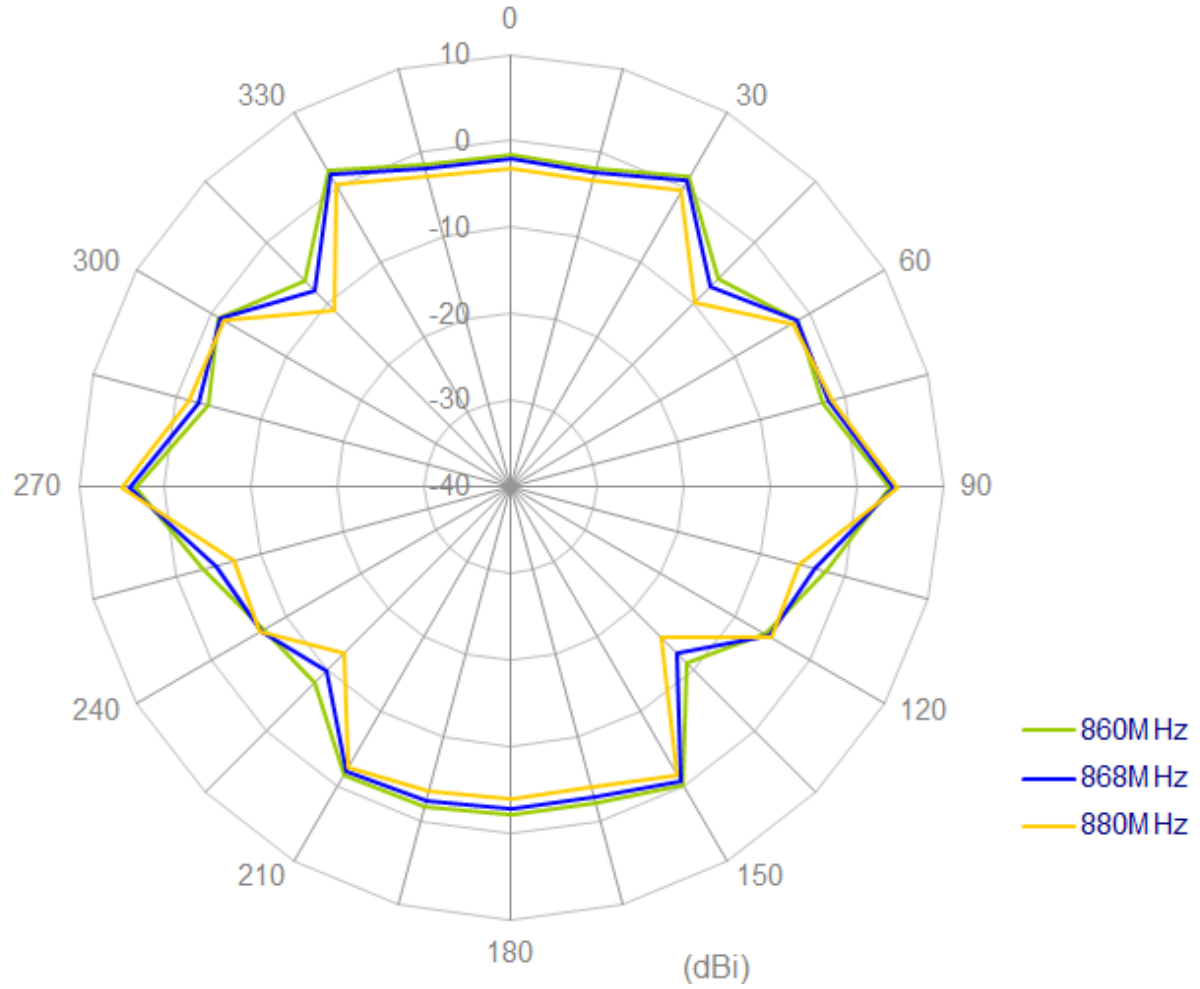

4. Drawing

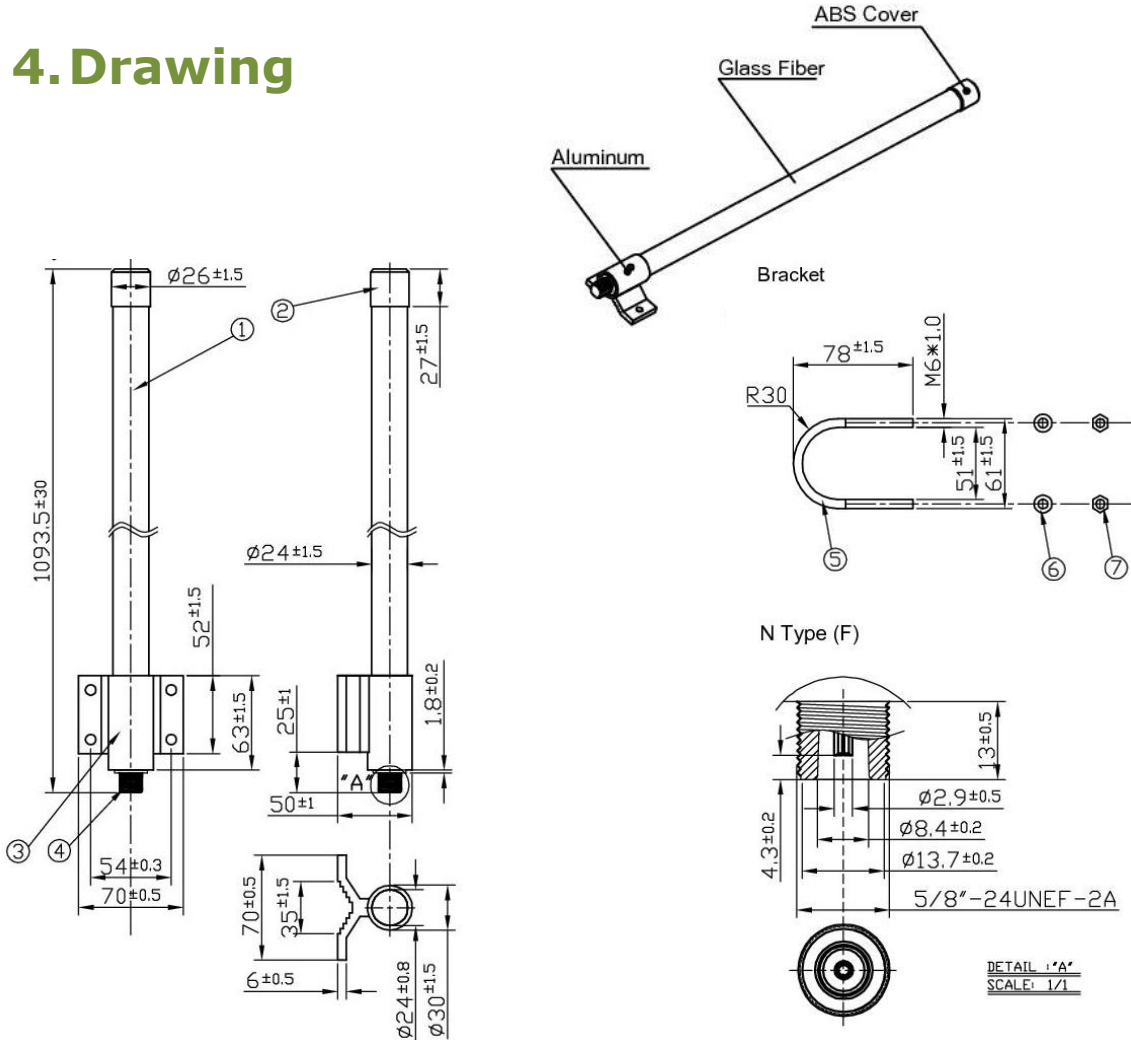

	Name	P/N	Material	Finish	QTY
1	OMB.868 Antenna	001212B010021A	Glass Fiber	White	1
2	Cover	000111K000021A	ABS	Silver	1
3	Holder	000311K000021A	Aluminum	Silver	1
4	N Type(F)	201211K000021A	Brass	Ni Plated	1
5	M6 U Type Screw	000411K000021A	Stainless Steel	Silver	2
6	M6 Washer	000411K010021A	Stainless Steel	Silver	4
7	M6 Nut	000411K020021A	Stainless Steel	Silver	4