

SPECIFICATION

- Part No. : **MA410.A.LBIJ.001**
- Product Name : MA410 Storm 4in1 Permanent Mount Antenna
LTE MIMO + GPS/GLONASS/BEIDOU + Satellite L Band
1621MHz
- Features : 2* LTE MIMO Antennas
698 to 960MHz/1710 to 2170MHz/
2490 to 2690MHz/3300 to 3600 MHz
1* Satellite L Band 1621MHz Antenna
1* GPS-GLONASS-BEIDOU Antenna
Screw-Mount [Permanent Mount]
Worldwide 4G Bands including 3G and 2G
Aerodynamic, Super Low-profile Vandal Resistant Housing
IP67 Enclosure
Dims: 216.24*93.25*30.95mm
1M cable (GNSS: RG-174)(LTE MIMO & SATELLITE L BAND
CFD-200) with SMA(M) connectors as standard
Custom Cables and Connectors Available
Product conforms to the EMC directive 2014/30/EU.

RoHS Compliant



1. Introduction

The Storm MA.410 antenna is a low profile, heavy-duty, fully IP67 waterproof external M2M antenna for use in worldwide telematics applications which combine Global Cellular, Location and Satellite Communications. MA.410 delivers best in class LTE, GNSS and Iridium antenna performance. You will never be out of touch with this extremely robust antenna.

At only 31mm high, the Storm is the world's lowest profile global telematics antenna solution. It delivers powerful worldwide 4G LTE MIMO antenna technology while also covering the 3G and 2G bands, plus BeiDou-GPS-GLONASS for next generation location accuracy, and 1621MHz L-band antenna for global satellite communications.

Typical applications

- High speed data links with a need for satellite communication as fallback
- Automotive and Heavy Equipment Vehicle Tracking and Telematics
- Remote Asset and Pipeline Monitoring
- HD Video over LTE
- First Responder and Emergency Services
- Global data communications/IoT

LTE 4G applications demand high speed data uplink and downlink. High efficiency and high gain MIMO antennas are necessary to achieve the required signal to noise ratio and throughput required to solve these challenges. Taoglas also takes care to have high isolation between the two MIMO antennas to prevent self-interference. The MA410 does not require a ground plane. Low loss cables are used to keep efficiency high over long cable lengths.

The GPS-Glonass-BeiDou active antenna receives efficiently on all three bands, leading to higher location accuracy and stability of tracking in urban environments. Finally a low axial ratio Satellite L Band 1621MHz Antenna is also embedded, providing connectivity for Satellite L Band systems, enabling global coverage, and back-up in

case of cellular network failure. Cable length and connector types are customizable. Contact your regional Taoglas sales office for support.

Conformity is declared under the following standard: **EN55022 Class B**

This is to declare that the product listed above conform to the EMC directive 2014/30/EU.

2. Specification

GPS-GLONASS-BeiDou				
Center Frequency	BeiDou: 1561.098±2.046MHz GPS: 1575.42±1.023MHz GLONASS: 1602±5MHz			
Passive Antenna efficiency	BeiDou: 45% GPS: 45% GLONASS: 48%			
VSWR	< 2:1			
Impedance	50Ω			
Axial Ratio	BeiDou: <5.5 GPS: <3.2 GLONASS: <10.6			
Polarization	RHCP			
Cable	1 meter RG174 standard, fully customizable			
Connector	SMA(M), standard, fully customizable			
LNA and Filter Electrical Properties				
Center Frequency	BeiDou: 1561.098±2.046MHz GPS: 1575.42±1.023MHz GLONASS: 1602±5MHz			
Out of Band Attenuation	1550~1650MHz 11dB Min 1651~1700MHz & 1549~1500MHz 25dB Min			
Pout 1dB gain Compression point	-6dBm Min. -2 dbm Typ.			
Output Impedance	50 Ohm			
VSWR	< 2:1			
Return Loss	10 dB Min.			
LNA Gain, Power consumption, and Noise Figure@GPS	Voltage	LNA Gain (Typ)	Power Consumption (Typ)	Noise Figure (Typ)
	Min 1.8V	20dB	5mA	2.7dB
	Typ 3.0V	28dB	10mA	2.4dB
	Max 5.5V	31dB	23mA	2.6dB
Total specification(Through Antenna, LNA)				
Frequency	1561.098±2.046MHz	1575.42±1.023MHz	1602±5MHz	
Gain@3V	1561MHz: 29±3dBi	1575.42MHz: 29±3dBi	1602MHz: 32±3dBi	
Output Impedance	50Ω			

2G/3G/4G MIMO1 Antenna

Frequency (MHz)		LTE700	GSM850	GSM900	DCS	PCS	UMTS1	LTE2600	LTE3500
		698~803	824~894	880~960	1710~1880	1850~1990	1920~2170	2490~2690	3300~3600
Efficiency (%)									
On the 50*50cm ground plane	30cm	62.06	41.76	49.16	44.93	59.56	59.39	55.42	37.39
	1M	59.27	39.88	46.95	40.98	54.46	54.71	50.55	33.33
	2M	55.31	36.93	42.81	36.86	48.53	48.56	43.53	27.99
	3M	51.62	34.20	39.76	32.65	42.73	42.47	36.84	23.59
	5M	44.25	28.85	33.36	25.50	32.98	32.90	28.22	16.96
In free space	30cm	65.08	48.08	55.44	49.41	57.62	59.92	54.98	38.19
	1M	62.15	45.91	52.95	45.06	52.69	55.18	50.14	34.83
	2M	58.00	42.54	48.29	40.62	46.96	48.99	43.17	29.65
	3M	54.13	39.46	44.80	35.92	41.31	42.84	36.53	24.66
	5M	46.39	33.24	37.60	28.10	31.89	33.19	27.99	19.14
Average Gain(dBi)									
On the 50*50cm ground plane	30cm	-2.22	-3.98	-3.20	-3.55	-2.27	-2.27	-2.57	-4.36
	1M	-2.42	-4.18	-3.40	-3.95	-2.66	-2.63	-2.97	-4.86
	2M	-2.72	-4.51	-3.80	-4.40	-3.16	-3.14	-3.62	-5.61
	3M	-3.02	-4.84	-4.13	-4.94	-3.72	-3.73	-4.35	-6.36
	5M	-3.70	-5.58	-4.88	-6.00	-4.84	-4.84	-5.50	-7.79
In free space	30cm	-2.02	-3.19	-2.60	-3.11	-2.42	-2.23	-2.62	-4.25
	1M	-2.22	-3.39	-2.80	-3.51	-2.81	-2.59	-3.02	-4.65
	2M	-2.52	-3.72	-3.20	-3.97	-3.31	-3.10	-3.67	-5.35
	3M	-2.82	-4.05	-3.52	-4.50	-3.86	-3.69	-4.39	-6.15
	5M	-3.50	-4.79	-4.28	-5.57	-4.98	-4.80	-5.55	-7.25
Peak Gain(dBi)									
On the 50*50cm ground plane	30cm	5.37	3.66	4.35	6.24	7.04	7.11	7.91	6.46
	1M	5.17	3.46	4.15	5.84	6.64	6.81	7.51	5.96
	2M	4.87	3.06	3.75	5.34	6.14	6.31	6.91	5.16
	3M	4.57	2.76	3.45	4.84	5.64	5.71	6.21	4.46
	5M	3.87	2.06	2.65	3.74	4.44	4.61	5.11	4.82
In free space	30cm	3.54	4.07	4.13	4.67	6.57	6.69	8.11	4.00
	1M	3.34	3.87	3.93	4.27	6.17	6.35	7.71	3.60
	2M	3.04	3.47	3.53	3.77	5.67	5.79	7.11	2.90
	3M	2.74	3.17	3.23	3.27	5.07	5.19	6.41	2.10
	5M	2.04	2.37	2.43	2.17	3.97	4.09	5.31	1.00

2G/3G/4G MIMO2 Antenna

Frequency (MHz)		LTE700	GSM850	GSM900	DCS	PCS	UMTS1	LTE2600	LTE3500
		698~803	824~894	880~960	1710~1880	1850~1990	1920~2170	2490~2690	3300~3600
Efficiency (%)									
On the 50*50cm ground plane	30cm	64.02	46.23	45.95	66.28	61.93	55.94	67.23	32.20
	1M	61.13	44.15	43.91	60.45	56.58	51.48	61.32	28.70
	2M	57.05	40.91	40.05	54.37	50.43	45.69	52.80	24.24
	3M	53.25	37.91	37.20	48.10	44.46	39.97	44.69	20.32
	5M	45.57	31.95	31.19	37.61	34.31	30.95	34.23	14.73
In free space	30cm	55.35	40.93	43.23	62.98	59.12	53.24	67.13	31.79
	1M	52.86	39.09	41.29	57.44	54.01	49.00	61.23	28.99
	2M	49.33	36.19	37.65	51.67	48.14	43.49	52.73	24.68
	3M	46.04	33.55	34.96	45.71	42.45	38.04	44.63	20.53
	5M	39.41	28.29	29.34	35.75	32.75	29.46	34.18	15.93
Average Gain(dBi)									
On the 50*50cm ground plane	30cm	-2.17	-3.38	-3.48	-1.84	-2.17	-2.57	-1.73	-5.25
	1M	-2.37	-3.58	-3.68	-2.24	-2.56	-2.93	-2.13	-5.75
	2M	-2.67	-3.91	-4.08	-2.69	-3.06	-3.44	-2.78	-6.50
	3M	-2.97	-4.23	-4.41	-3.23	-3.62	-4.03	-3.50	-7.25
	5M	-3.64	-4.98	-5.17	-4.29	-4.74	-5.14	-4.66	-8.68
In free space	30cm	-2.87	-3.93	-3.71	-2.04	-2.39	-2.80	-1.73	-5.28
	1M	-3.07	-4.13	-3.91	-2.44	-2.78	-3.16	-2.13	-5.68
	2M	-3.37	-4.46	-4.31	-2.90	-3.28	-3.67	-2.78	-6.38
	3M	-3.67	-4.79	-4.63	-3.43	-3.84	-4.26	-3.51	-7.18
	5M	-4.35	-5.53	-5.39	-4.50	-4.96	-5.37	-4.67	-8.28
Peak Gain(dBi)									
On the 50*50cm ground plane	30cm	6.51	4.09	3.82	7.93	8.06	7.89	8.16	2.67
	1M	6.31	3.89	3.62	7.53	7.66	7.49	7.76	2.17
	2M	6.01	3.59	3.22	7.03	7.16	6.99	7.16	1.42
	3M	5.71	3.19	2.92	6.53	6.66	6.49	6.46	0.67
	5M	5.01	2.49	2.22	5.43	5.46	5.29	5.36	-0.76
In free space	30cm	5.21	2.85	3.16	7.48	7.48	7.29	8.13	2.67
	1M	5.01	2.65	2.96	7.08	7.08	6.89	7.73	2.27
	2M	4.71	2.25	2.56	6.58	6.58	6.39	7.13	1.57
	3M	4.41	1.95	2.26	6.08	6.08	5.88	6.43	0.77
	5M	3.71	1.15	1.46	4.98	4.98	4.69	5.33	-0.33
Impedance				50Ω					
Polarization				Linear					
VSWR				< 3.5					
Cable				1 meter CFD-200 standard, fully customizable					

SATELLITE L BAND 1621MHZ	
VSWR	< 2
Axial Ratio	<1.7
Polarization	RHCP
Antenna Gain	2dBi Typ. @Zenith
Antenna Efficiency	40%
Cable	1 meter CFD-200 standard, fully customizable
Connector	SMA(M), standard, fully customizable

MECHANICAL	
Antenna Dimensions	216.24*93.25*30.95mm
Casing	ABS+PC
Base and thread	Nickel Plated Aluminum
Weight	440g
Ingress Protection Rating	IP67
Maximum Assembly Torque	39.2 N-m
ENVIRONMENTAL	
Operation Temperature	-40°C to 85°C
Storage Temperature	-40°C to 90°C
Humidity	Non-condensing 65°C 95% RH

LTE BANDS				
Band Number	LTE/LTE- Advanced /WCDMA/HSPA.HSPA+			
	Uplink	Downlink	MIMO 1	MIMO 2
1	UL: 1920 to 1980	DL: 2110 to 2170	✓	✓
2	UL: 1850 to 1910	DL: 1930 to 1990	✓	✓
3	UL: 1710 to 1785	DL: 1805 to 1880	✓	✓
4	UL: 1710 to 1755	DL: 2110 to 2155	✓	✓
5	UL: 824 to 849	DL: 869 to 894	✓	✓
7	UL: 2500 to 2570	DL:2620 to 2690	✓	✓
8	UL: 880 to 915	DL: 925 to 960	✓	✓
9	UL: 1749.9 to 1784.9	DL: 1844.9 to 1879.9	✓	✓
11	UL: 1427.9 to 1447.9	DL: 1475.9 to 1495.9	✗	✗
12	UL: 699 to 716	DL: 729 to 746	✓	✓
13	UL: 777 to 787	DL: 746 to 756	✓	✓
14	UL: 788 to 798	DL: 758 to 768	✓	✓
17	UL: 704 to 716	DL: 734 to 746 (LTE only)	✓	✓
18	UL: 815 to 830	DL: 860 to 875 (LET only)	✓	✓
19	UL: 830 to 845	DL: 875 to 890	✓	✓
20	UL: 832 to 862	DL: 791 to 821	✓	✓
21	UL: 1447.9 to 1462.9	DL: 1495.9 to 1510.9	✗	✗
22	UL: 3410 to 3490	DL: 3510 to 3590	✓	✗
23	UL:2000 to 2020	DL: 2180 to 2200 (LTE only)	✓	✓
24	UL:1625.5 to 1660.5	DL: 1525 to 1559 (LTE only)	✓	✓
25	UL: 1850 to 1915	DL: 1930 to 1995	✓	✓
26	UL: 814 to 849	DL: 859 to 894	✓	✓
27	UL: 807 to 824	DL: 852 to 869 (LTE only)	✓	✓
28	UL: 703 to 748	DL: 758 to 803 (LTE only)	✓	✓
29	UL: -	DL: 717 to 728 (LTE only)	✓	✓
30	UL: 2305 to 2315	DL: 2350 to 2360 (LTE only)	✓	✓
31	UL: 452.5 to 457.5	DL: 462.5 to 467.5 (LTE only)	✗	✗
32	UL: -	DL: 1452 - 1496	✗	✗
35		1850 to 1910	✓	✓
38		2570 to 2620	✓	✓
39		1880 to 1920	✓	✓
40		2300 to 2400	✓	✓
41		2496 to 2690	✓	✓
42		3400 to 3600	✓	✗
43		3600 to 3800	✗	✗

3. Antenna Characteristics

3.1 BeiDou-GPS-GLONASS Antenna

3.1.1 Block Diagram

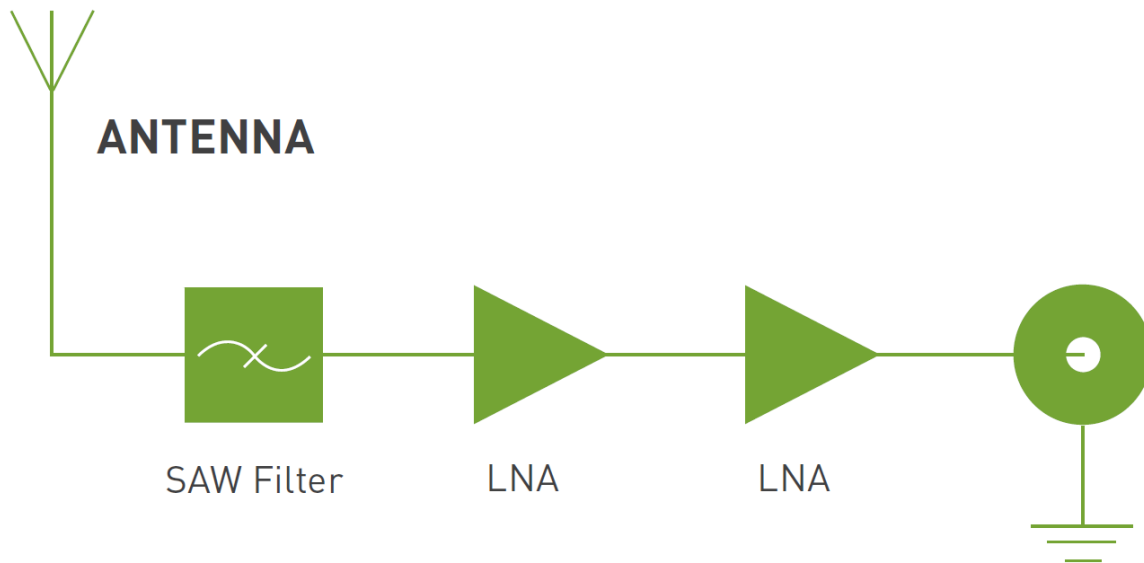

3.1.2 Test Setup

XZ Plane



YZ Plane

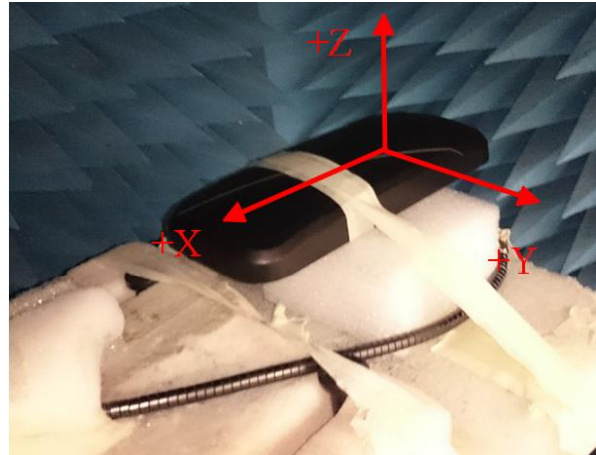

3.1.3 BeiDou-GPS-GLONASS Return Loss

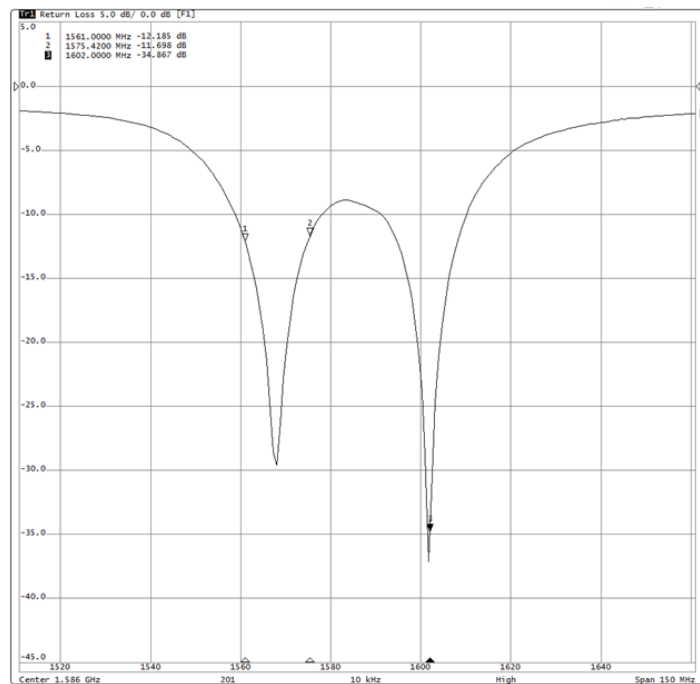

Return Loss : -12.185 dB @ 1561MHz

Return Loss : -11.698 dB @ 1575.42MHz

Return Loss : -34.867 dB @ 1602MHz

3.1.4 BeiDou-GPS-GLONASS Smith Chart

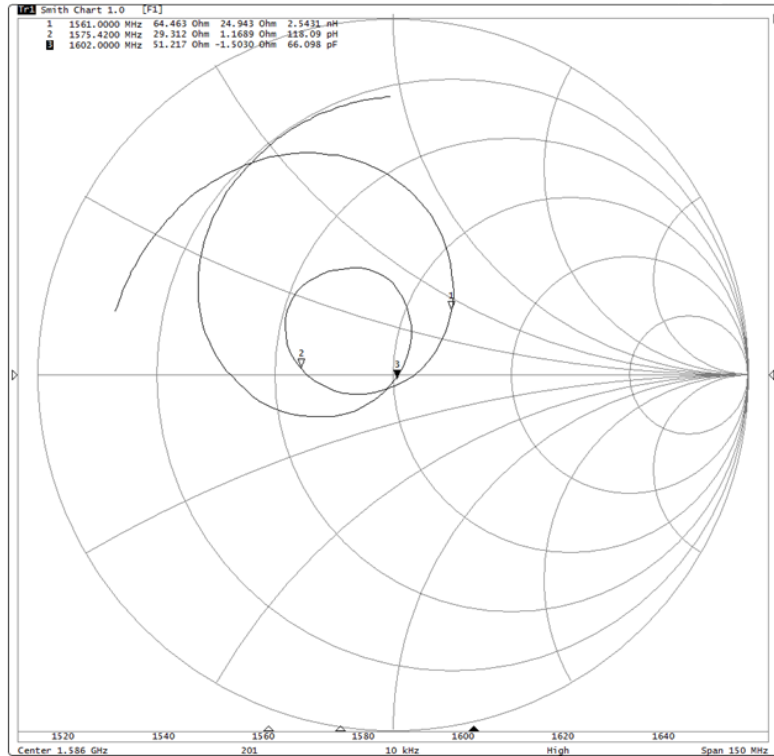

Impedance : $64.46 + j24.94$ Ohm@ 1561MHz

Impedance : $29.31 + j01.16$ Ohm@ 1575.42MHz

Impedance : $51.24 - j01.50$ Ohm@ 1602MHz

3.1.5 BeiDou-GPS-GLONASS Radiation Pattern

Radiation pattern @ 1561MHz

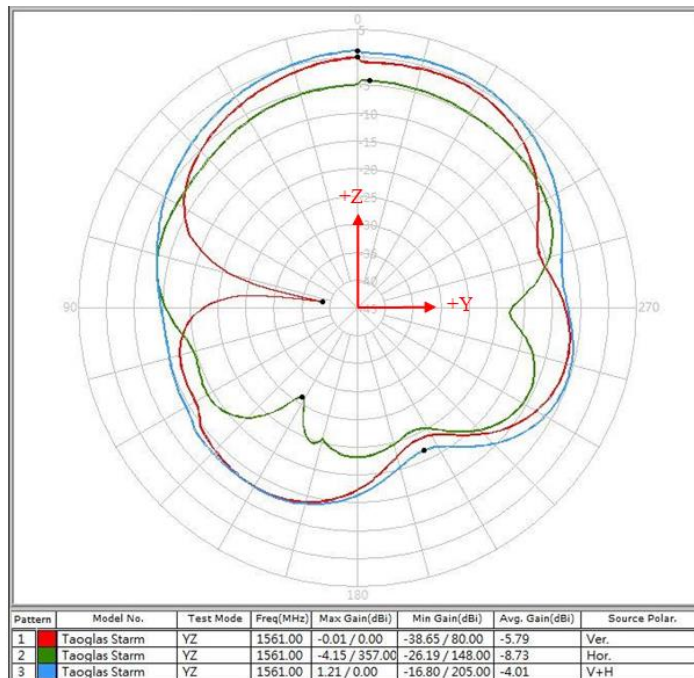
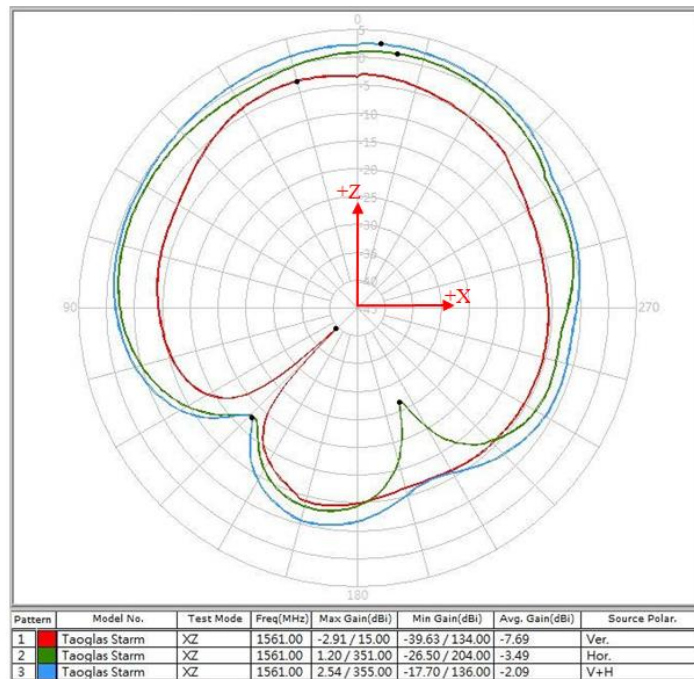

1561MHz		Peak Gain	Zenith Gain	(dBi)
V+H	XZ-Plane	2.54	2.19	
	YZ-Plane	1.21	1.16	

Radiation pattern @ 1575.42MHz

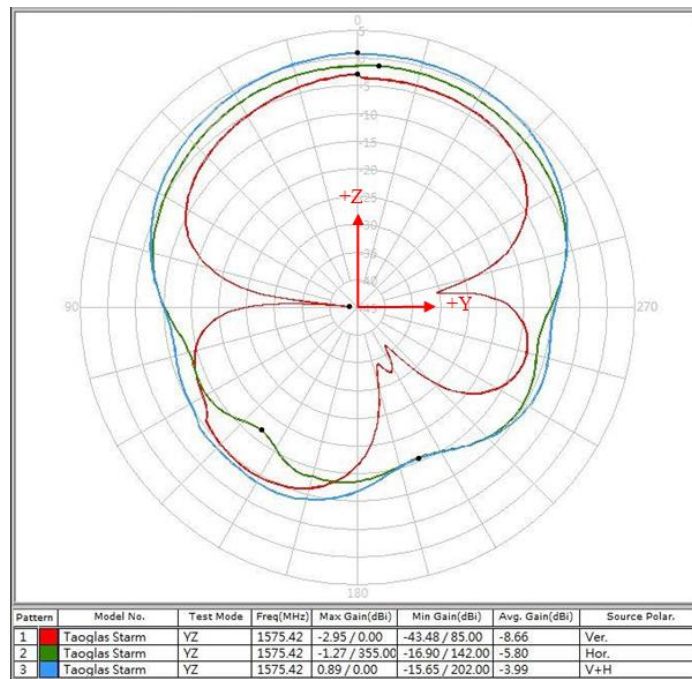
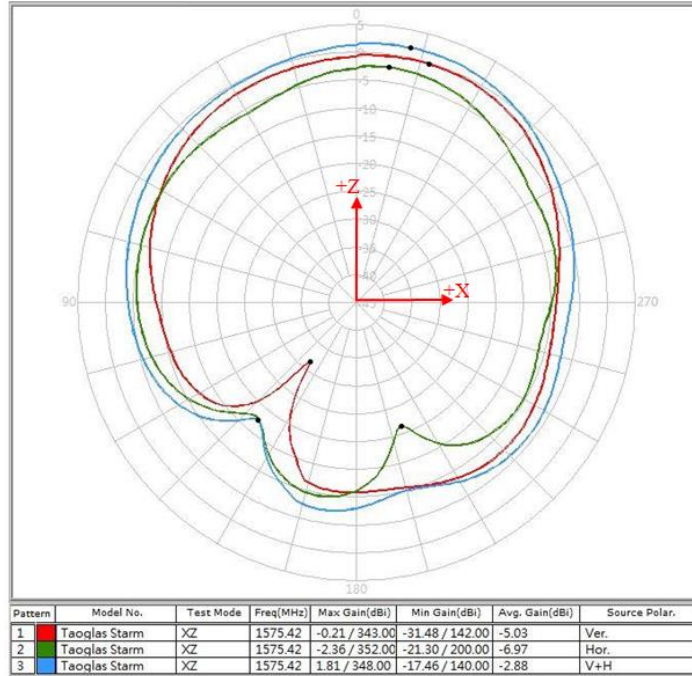

1575.42MHz		Peak Gain	Zenith Gain
V+H	XZ-Plane	1.81	1.25
	YZ-Plane	0.89	0.89

(dBi)

Radiation pattern @ 1602MHz

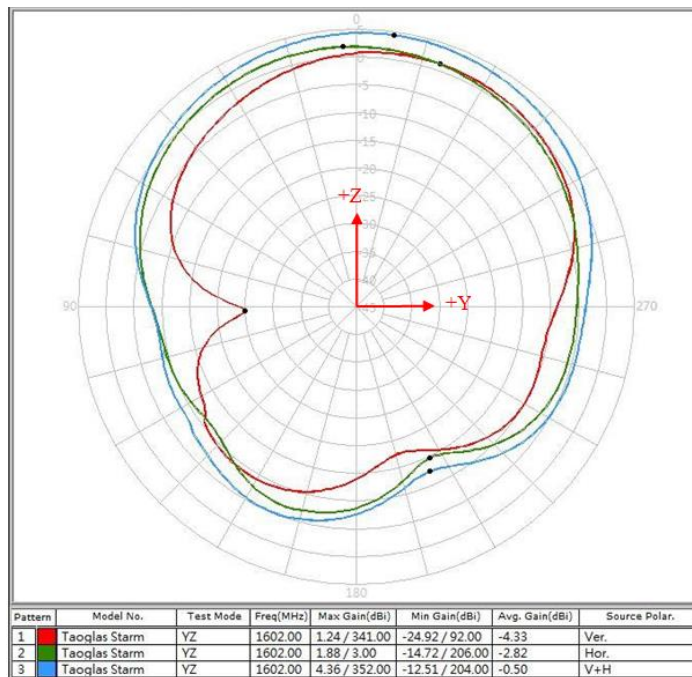
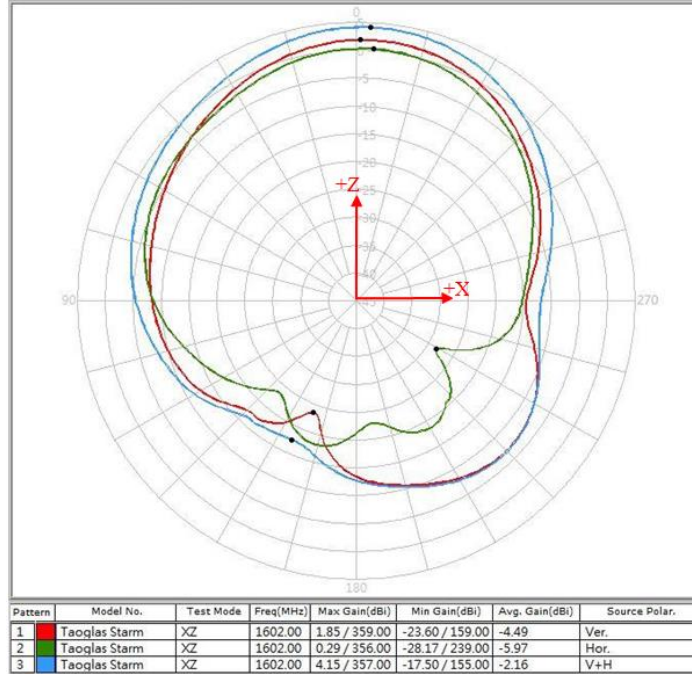

1602MHz		Peak Gain	Zenith Gain
V+H	XZ-Plane	4.15	4.08
	YZ-Plane	4.36	4.31

(dBi)

3.1.6 Axial Ratio Pattern

Frequency: 1561MHz

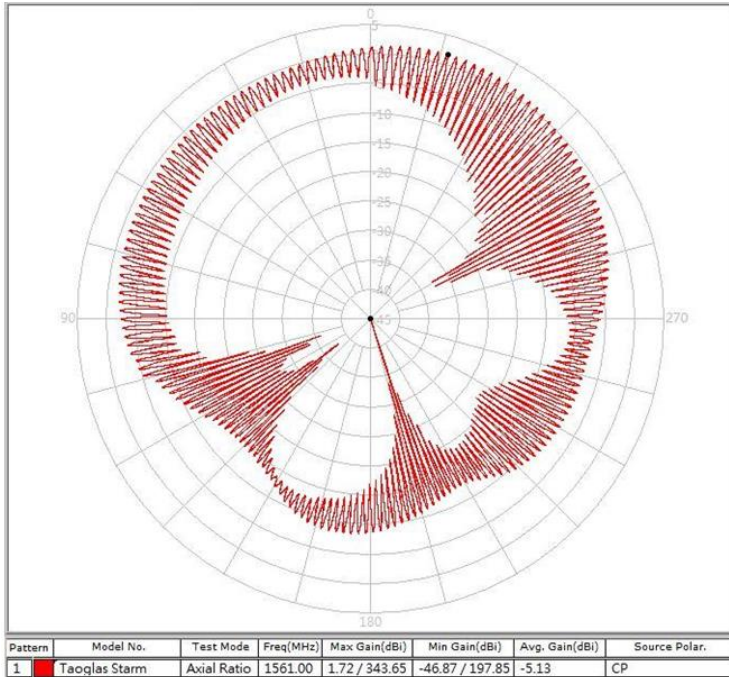

Angle	Axial Ratio
90°	8.03
75°	7.33
60°	6.74
45°	6.16
30°	4.45
15°	3.25
0°	4.93
345°	10.02
330°	14.36
315°	20.04
300°	31.37
285°	15.69
270°	5.79

Frequency: 1575.42MHz

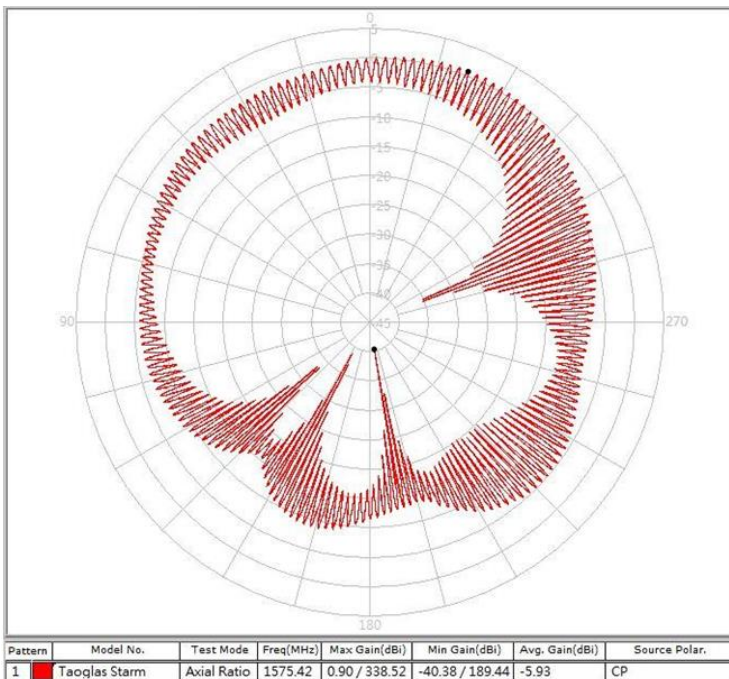

Angle	Axial Ratio
90°	2.89
75°	1.73
60°	2.57
45°	3.89
30°	4.88
15°	4.43
0°	2.77
345°	5.61
330°	8.09
315°	11.46
300°	19.67
285°	19.46
270°	8.11

Frequency: 1602MHz

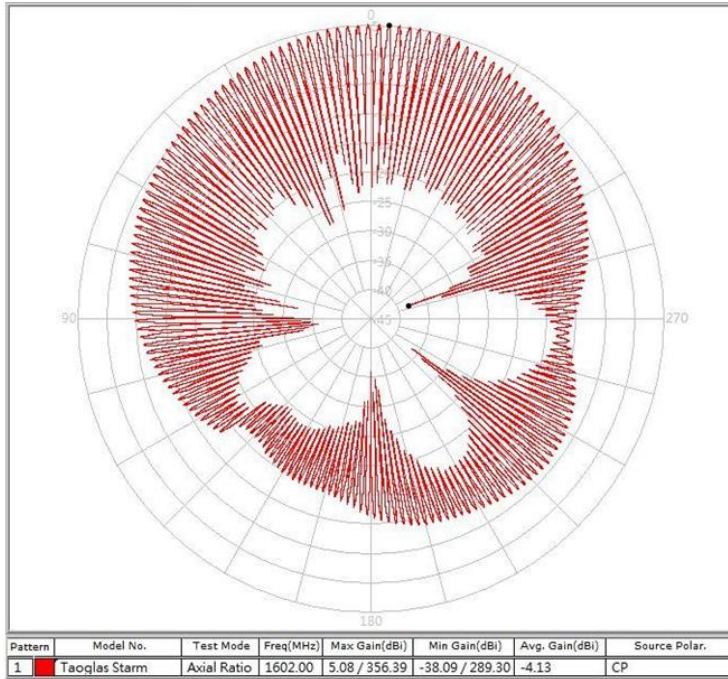

Angle	Axial Ratio
90°	29.65
75°	20.00
60°	22.48
45°	20.99
30°	25.20
15°	24.06
0°	10.14
345°	26.98
330°	24.1
315°	21.9
300°	19.5
285°	20.18
270°	4.5

3.1.7 BeiDou-GPS-GLONASS LNA Noise Figure

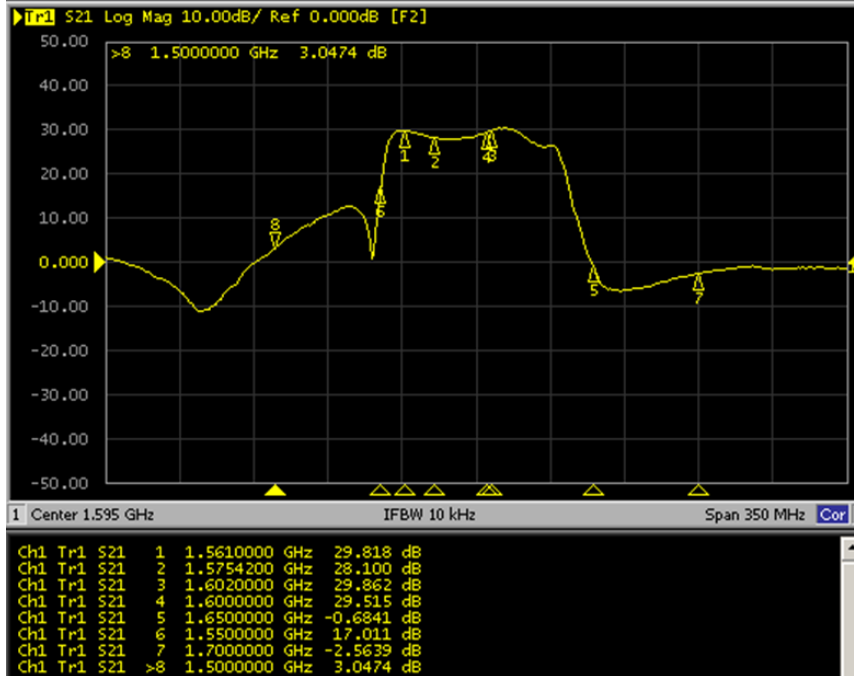

LNA Gain and Out Band Rejection @3.0V

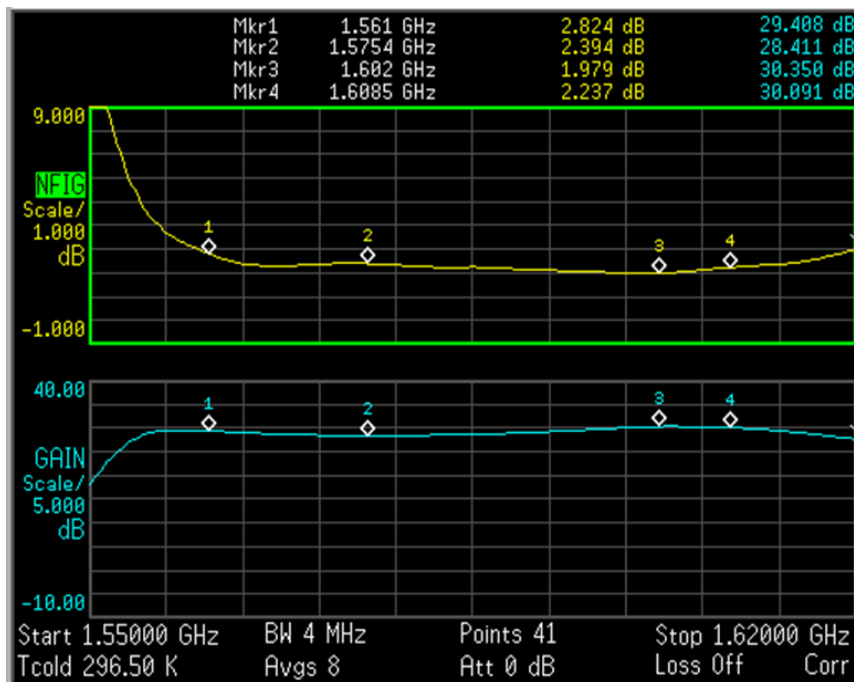

LNA Noise Figure @3.0V

3.2 Satellite L Band 1621MHz Antenna

3.2.1 Test setup

XZ Plane



YZ Plane

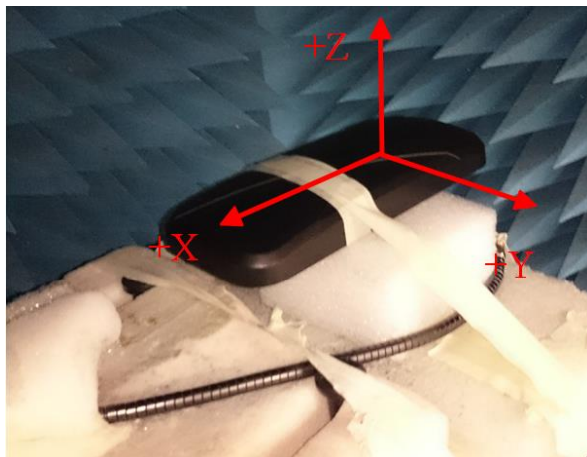

3.2.2 Satellite L Band VSWR

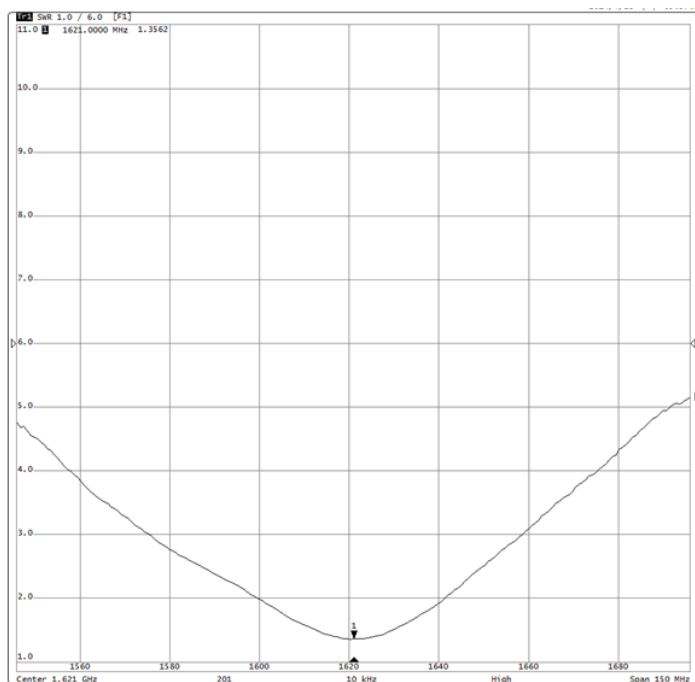

3.2.3 Satellite L Band Smith Chart

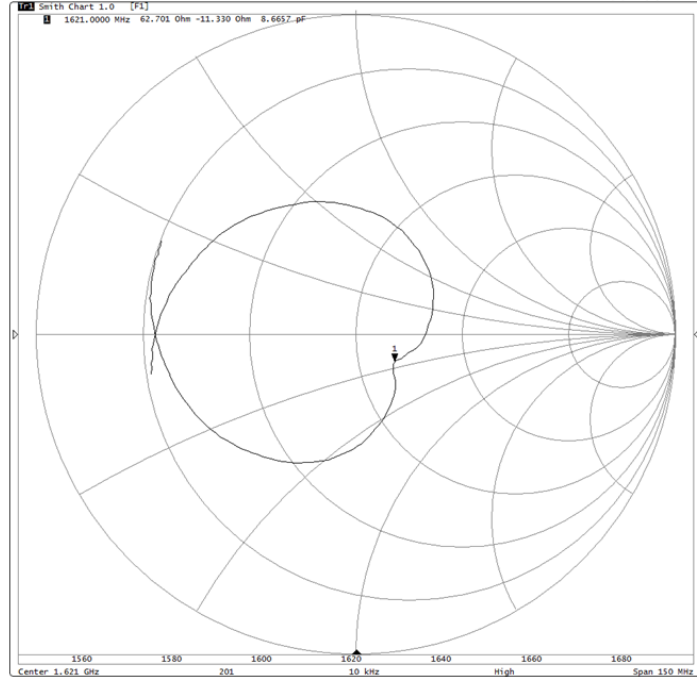

3.2.4 Satellite L Band Radiation Pattern

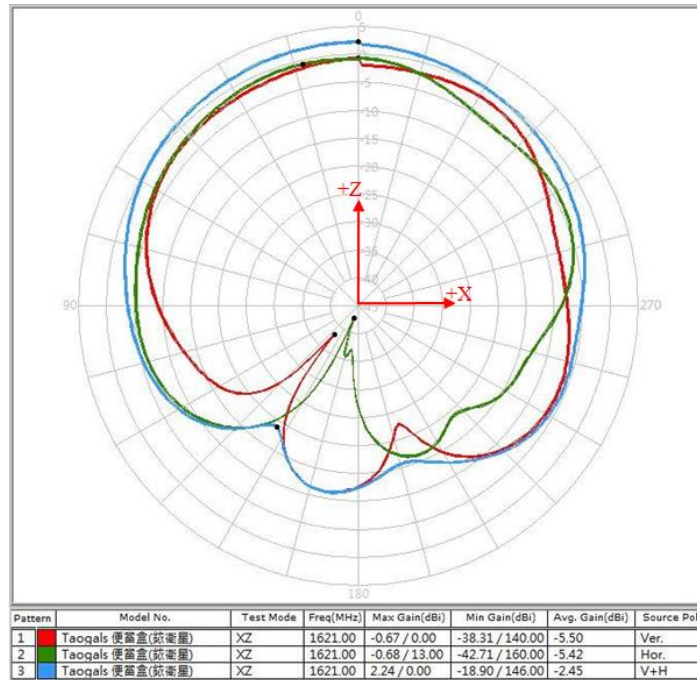

1621MHz		Peak Gain	Zenith Gain
V+H	XZ-Plane	2.24	2.24

(dBi)

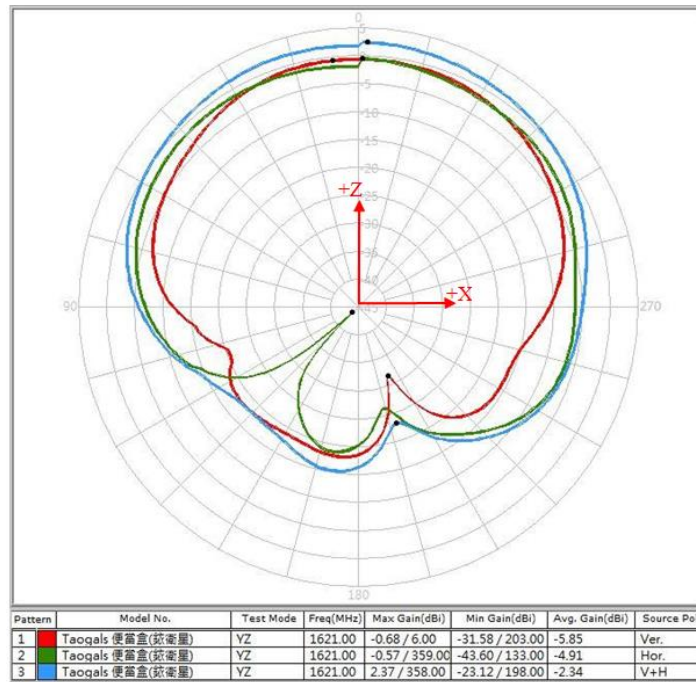

1621MHz		Peak Gain	Zenith Gain
V+H	YZ-Plane	2.37	2.3 (dBi)

3.2.5 Axial Ratio Pattern

Frequency: 1621MHz

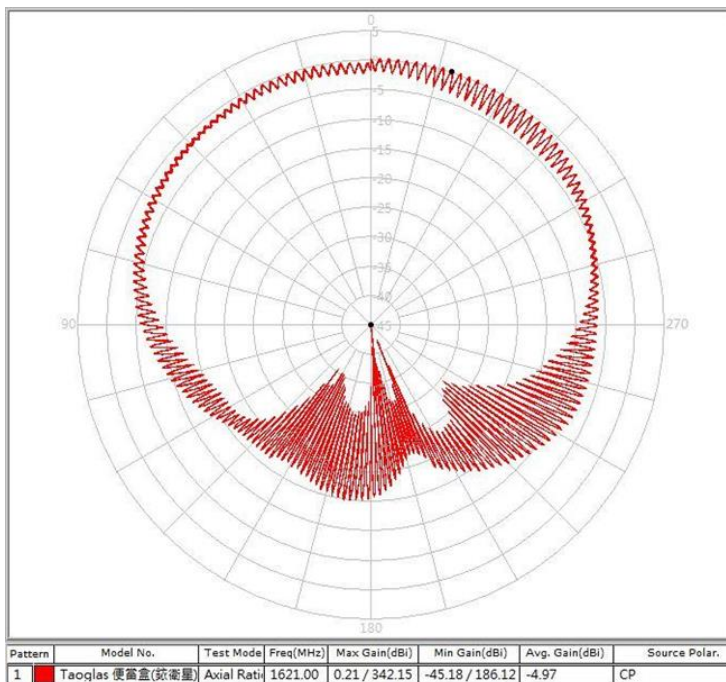

Angle	Axial Ratio
90°	3.44
75°	1.61
60°	0.89
45°	0.62
30°	1.05
15°	1.57
0°	1.21
345°	3.07
330°	4.1
315°	3.39
300°	1.45
285°	0.81
270°	3.21

3.3 LTE MIMO Antenna

3.3.1 Test Setup

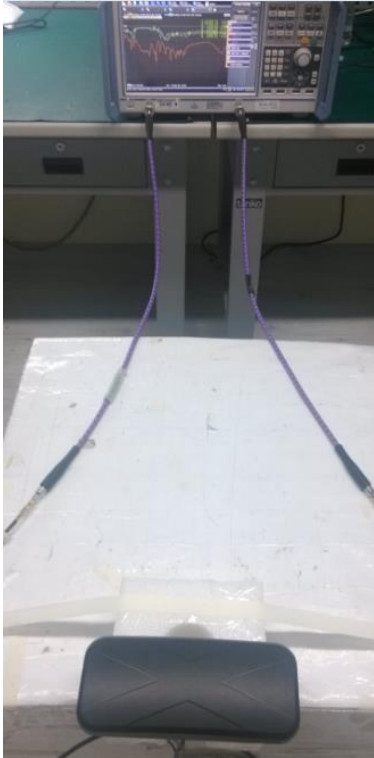

In free space

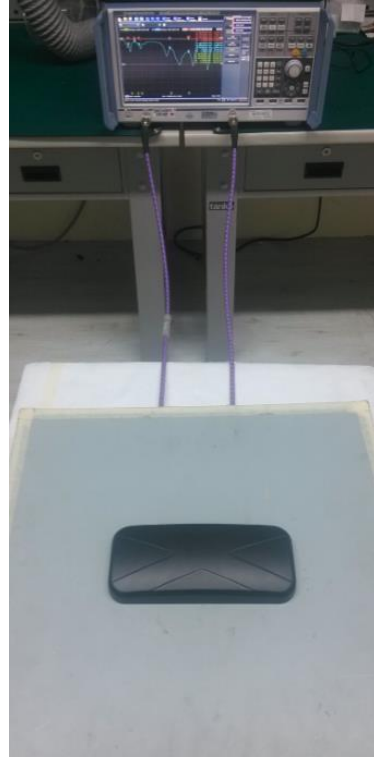

On the 50*50cm ground plane

3.3.2 LTE Antenna Return Loss and Isolation

Setup on the 50*50cm ground plane with 1 meter cable length

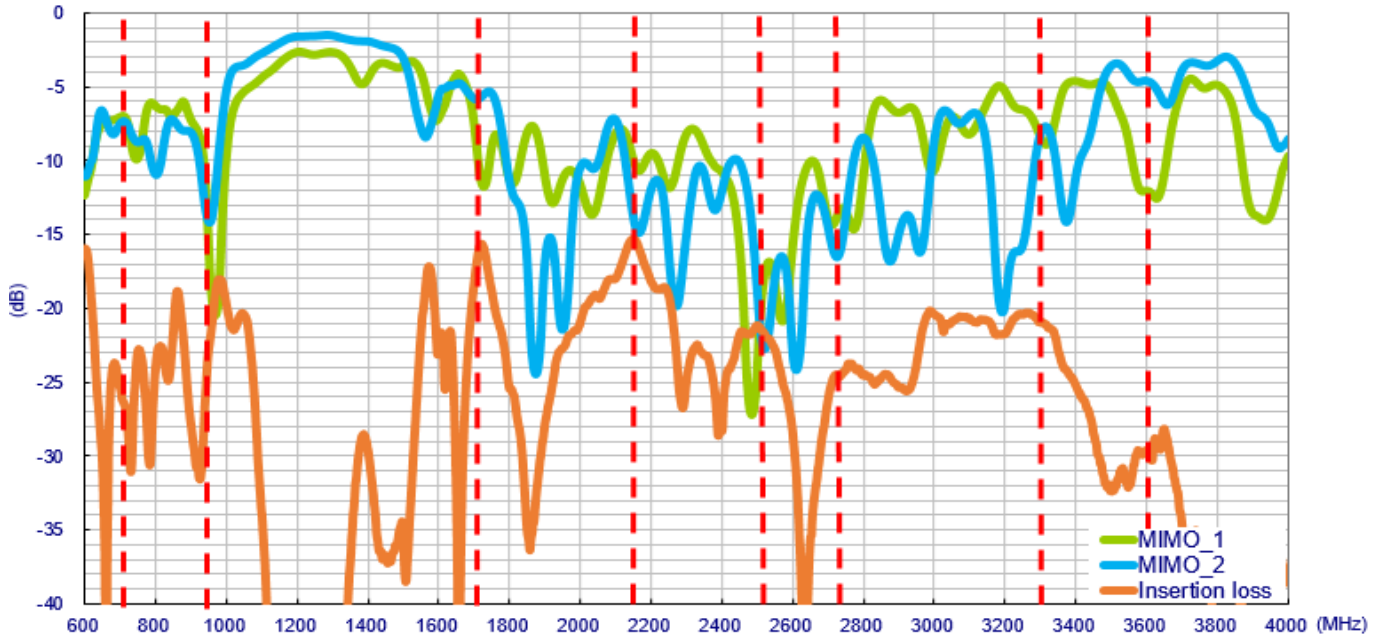

Setup in free space with 1 meter cable length

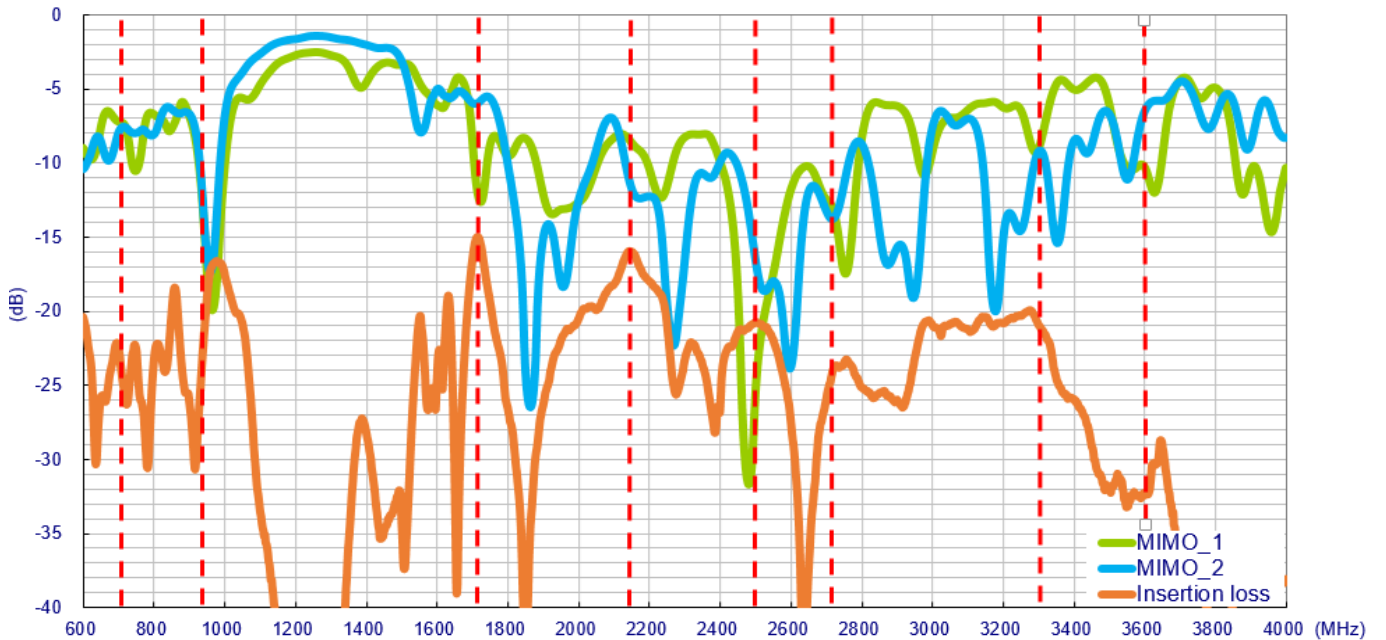

3.3.3 LTE Antenna Efficiency

Setup on the 50*50cm ground plane with 1 meter cable length

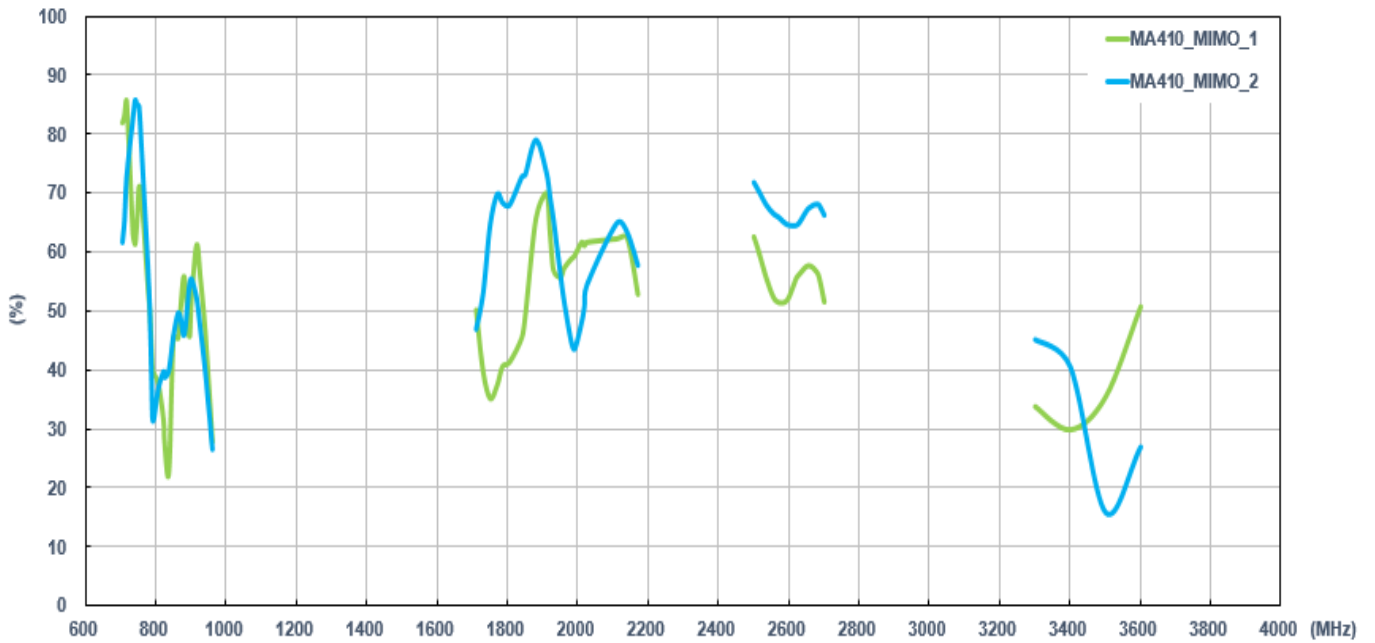

Setup in free space with 1 meter cable length

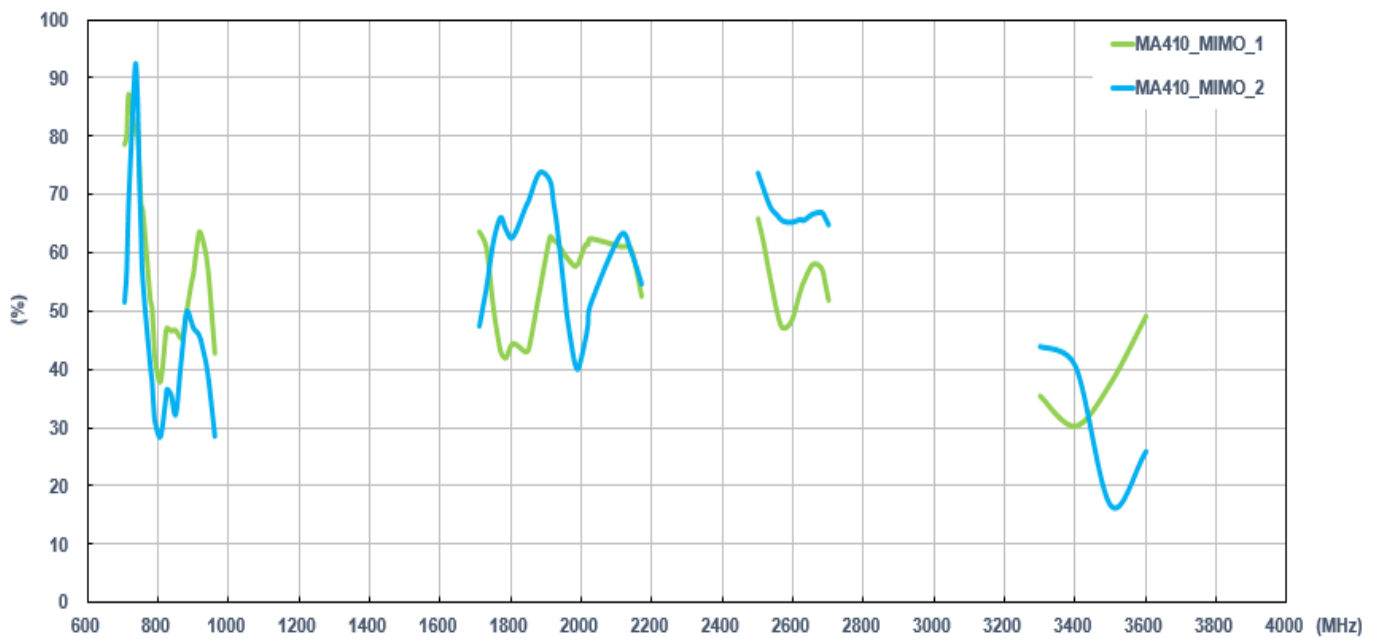

3.3.4 LTE Antenna Peak Gain

Setup on the 50*50cm ground plane with 1 meter cable length

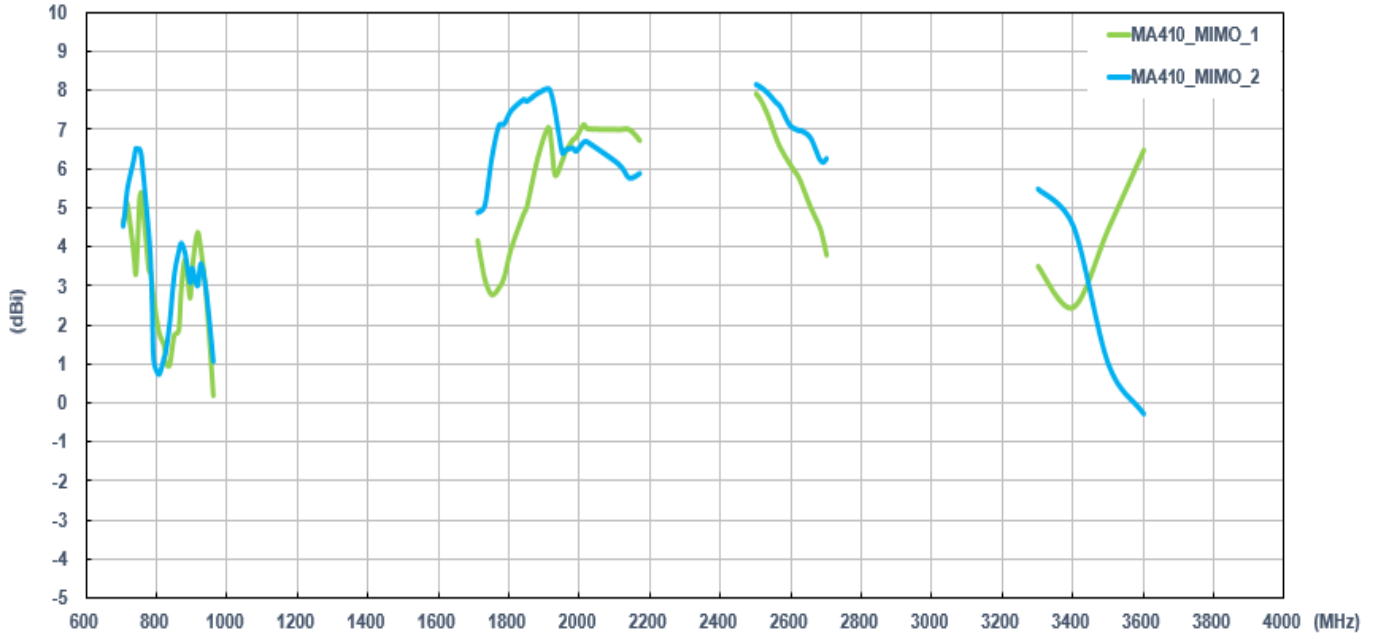

Setup in free space with 1 meter cable length

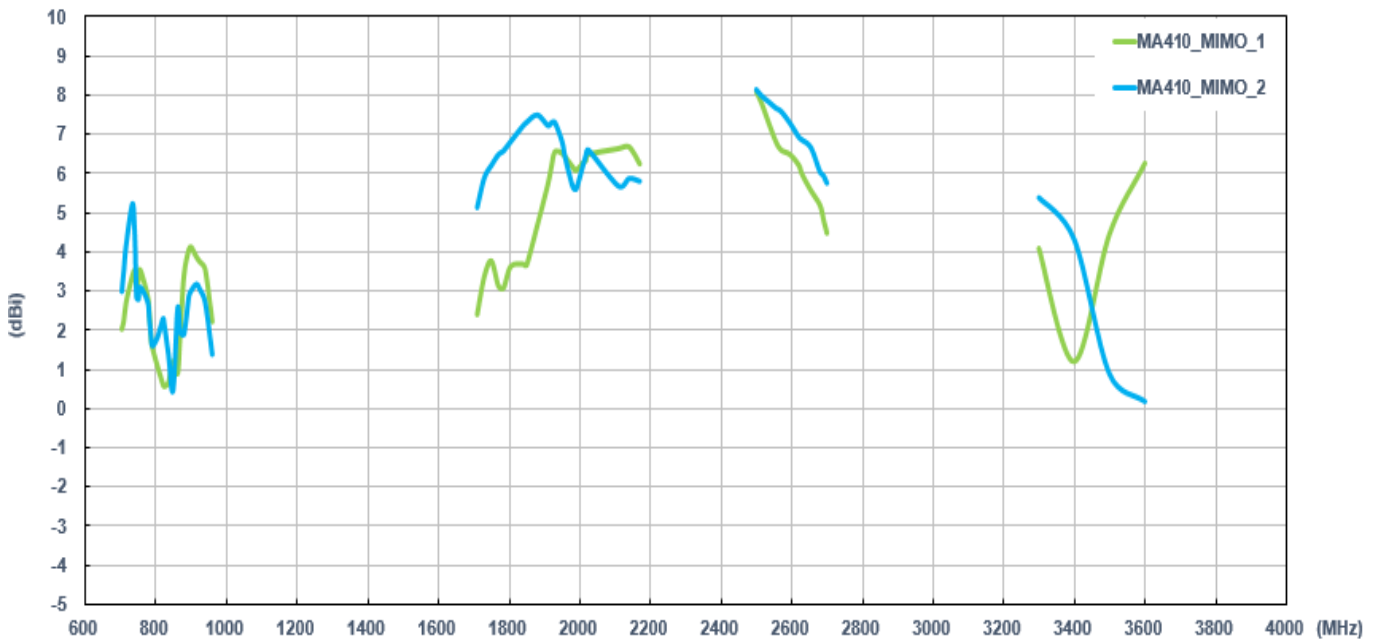

3.3.5 LTE Antenna Average gain

Setup on the 50*50cm ground plane with 1 meter cable length

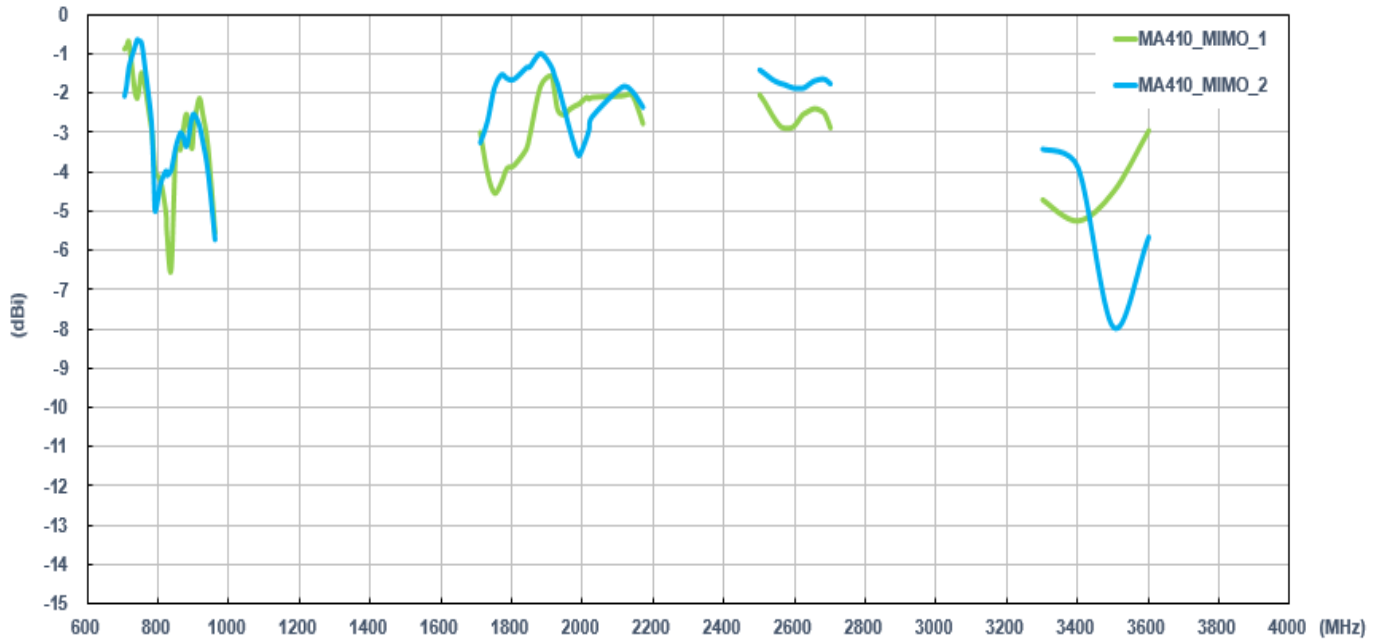

Setup in free space with 1 meter cable length

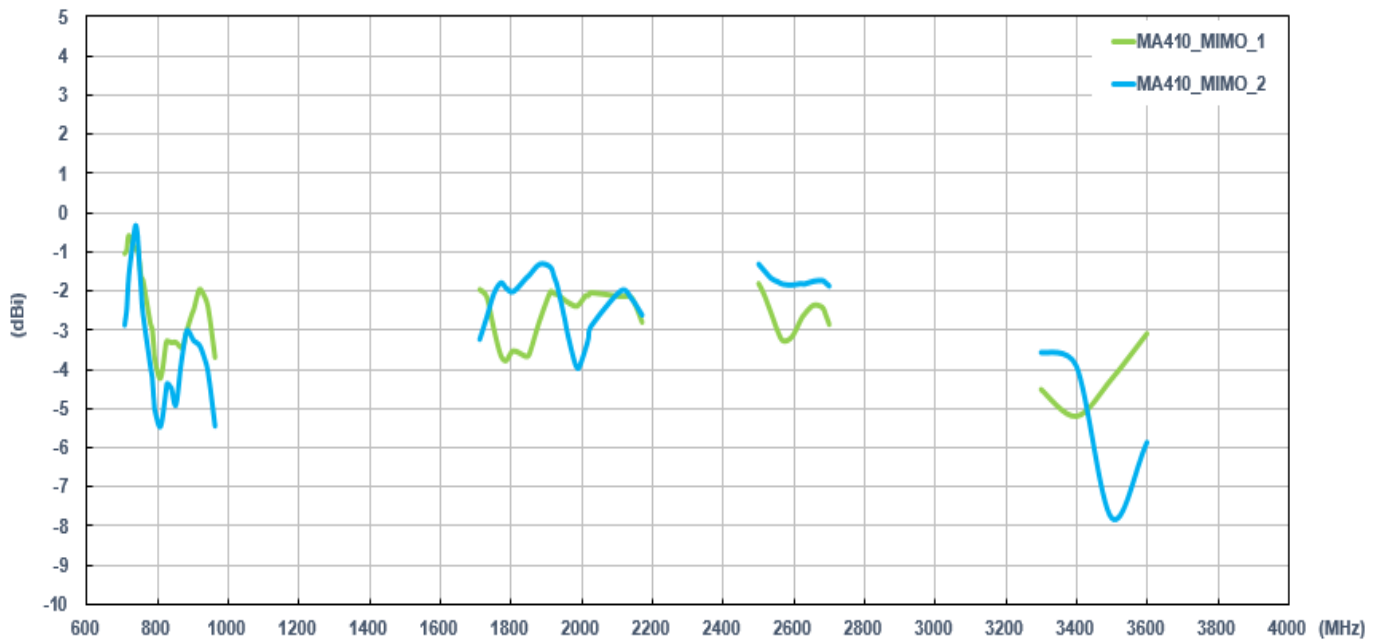

3.3.6 Test Setup for Antenna Radiation Pattern (ETS Anechoic chamber)

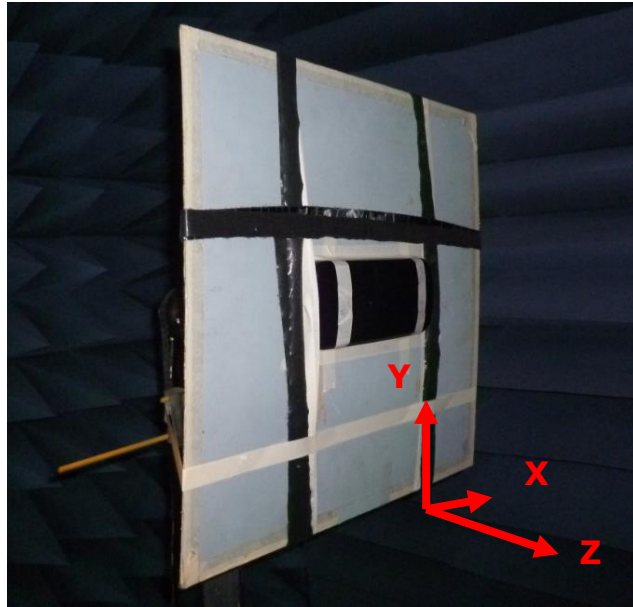

On the 50*50cm ground plane

3.3.7 2D Radiation pattern (MIMO1 with 1M cable length on the 50*50 ground plane)

XY Plane

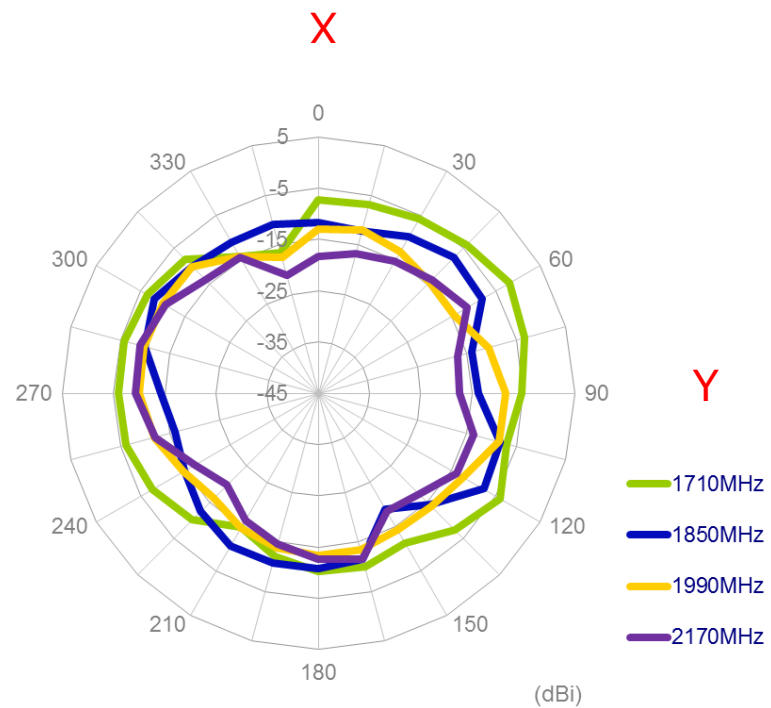
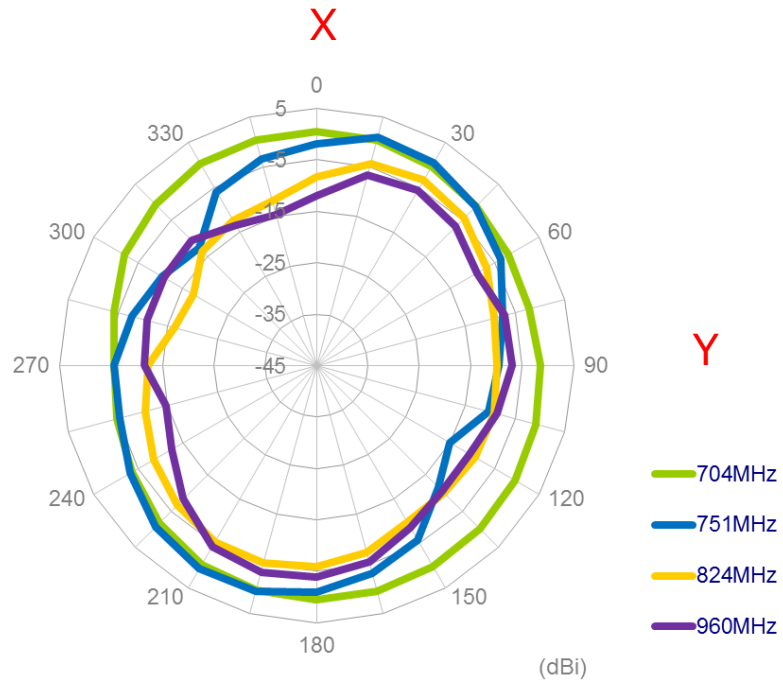

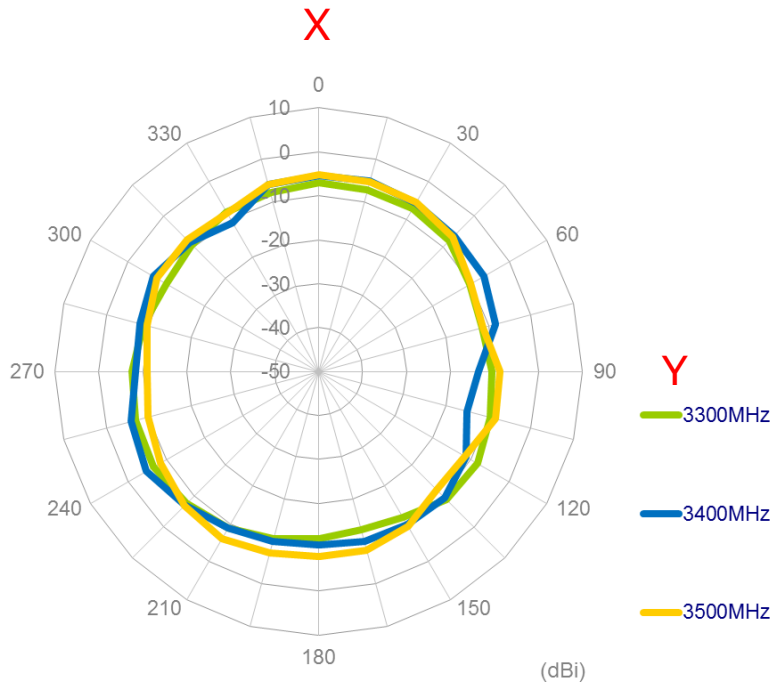
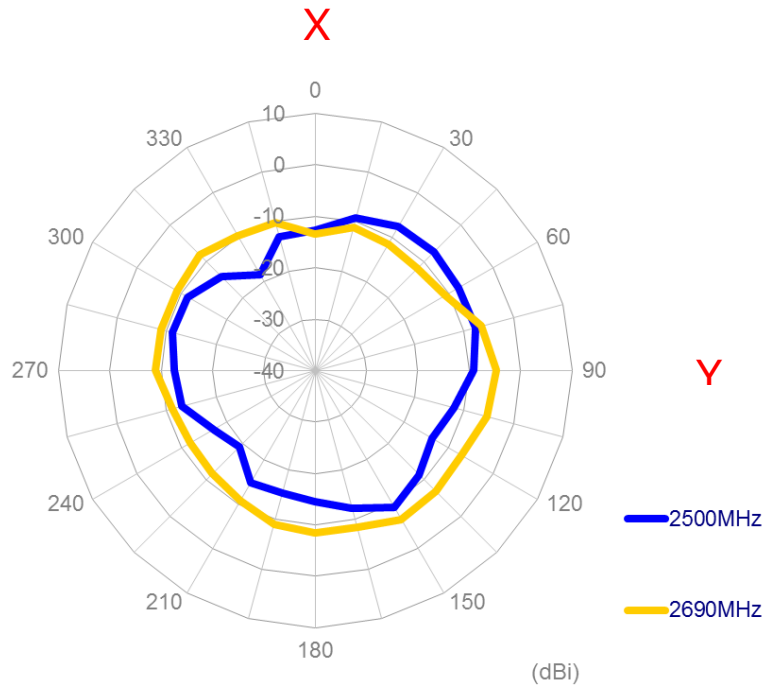

XZ Plane

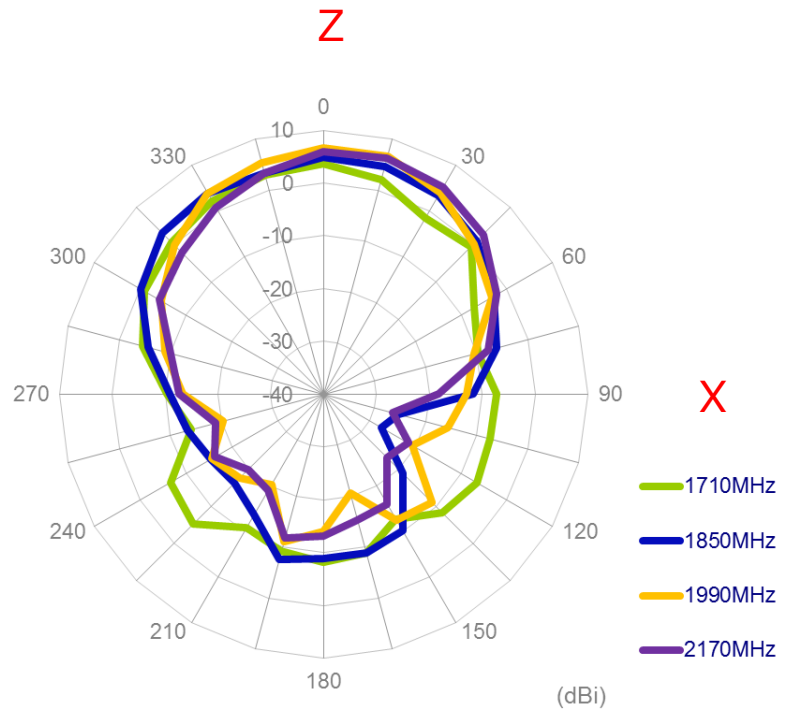
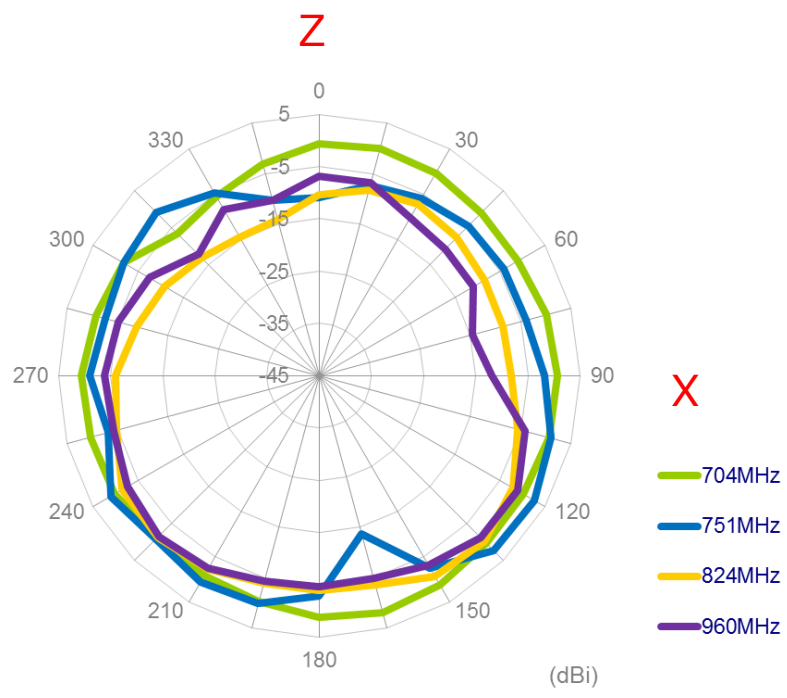

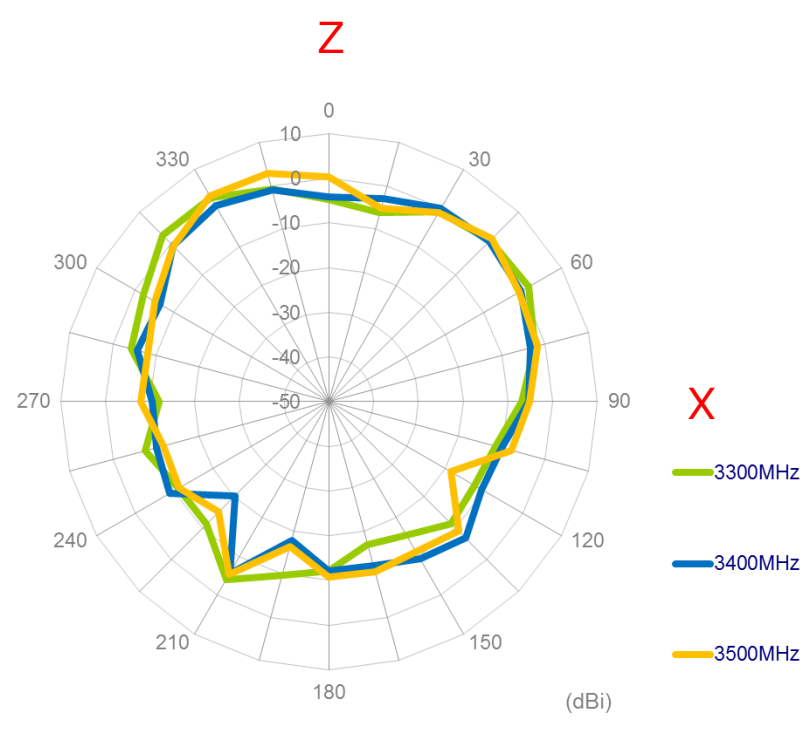
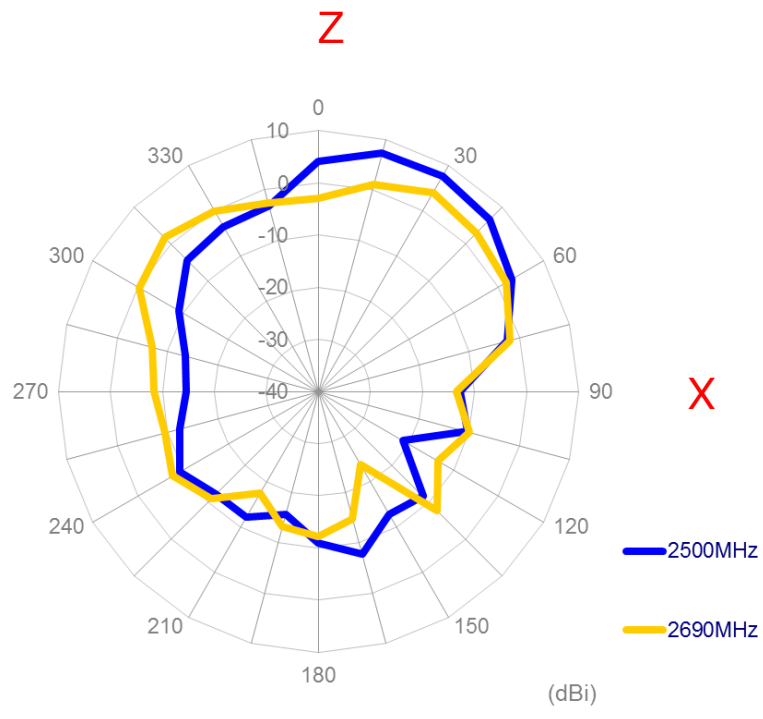

YZ Plane

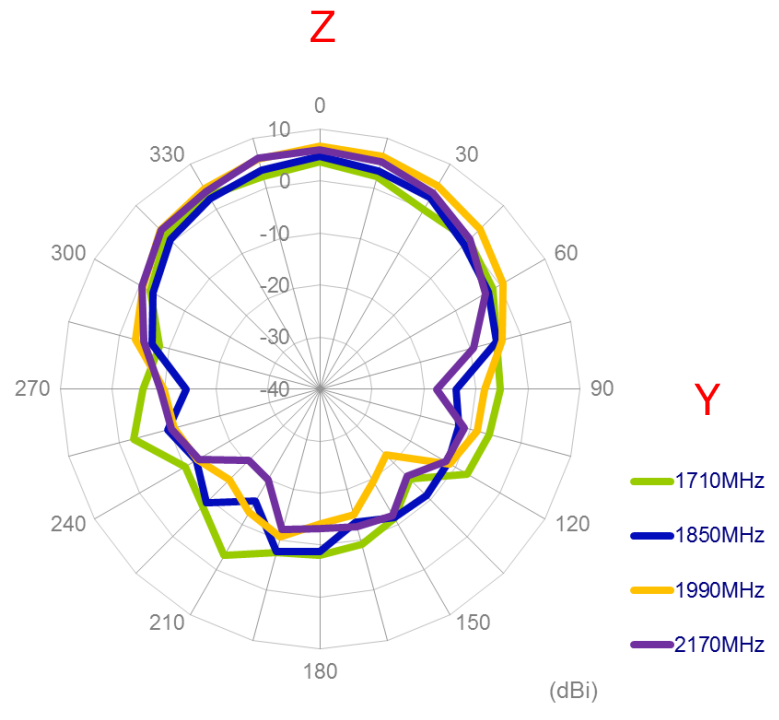
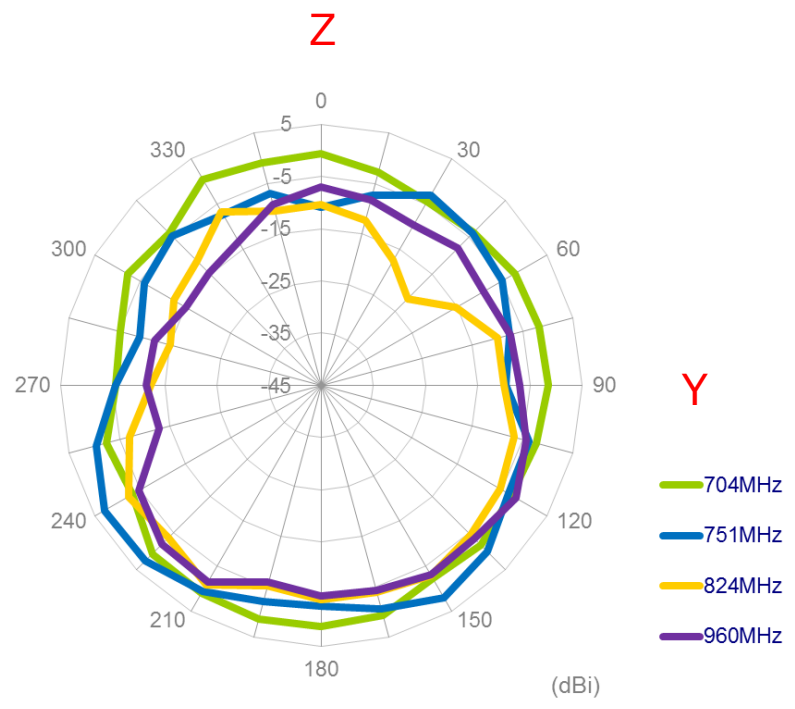

Z

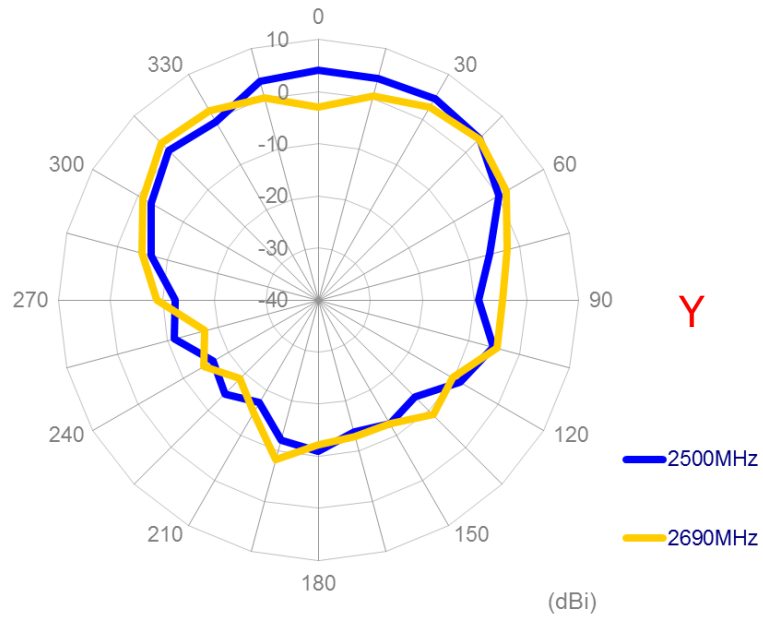

Z

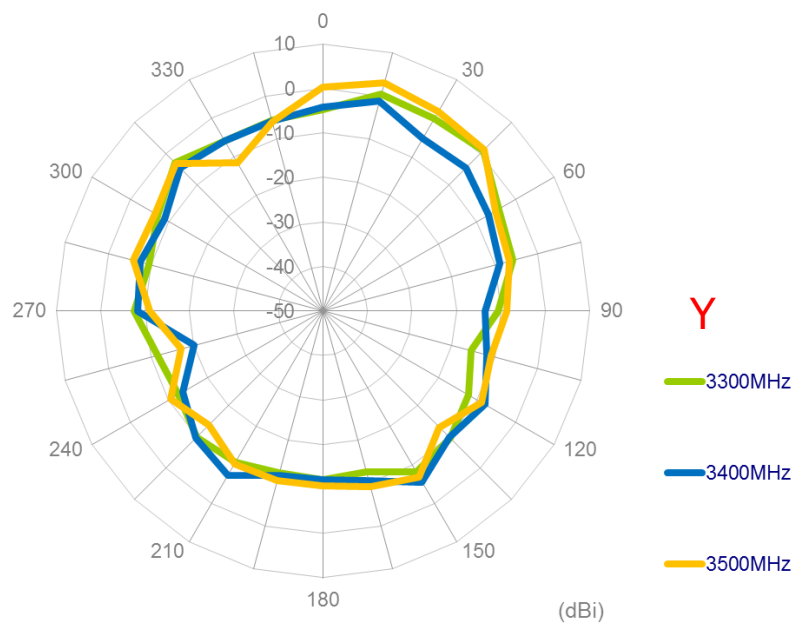

3.3.8 3D Radiation pattern (MIMO1 with 1M cable length on the 50*50 ground plane)

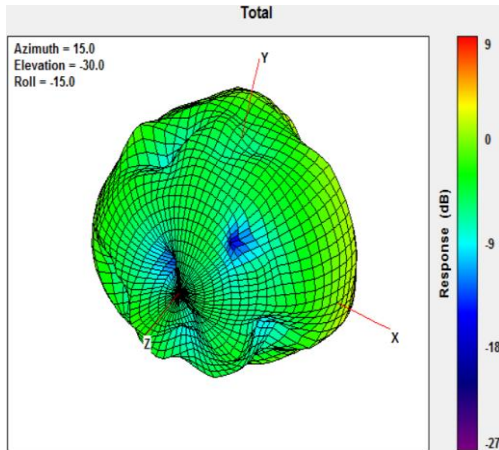

704MHz

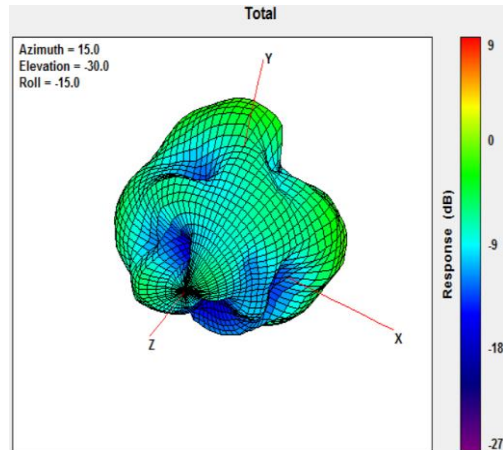

960MHz

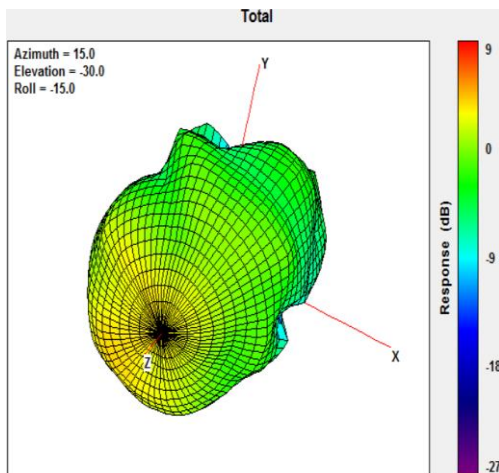

1710MHz

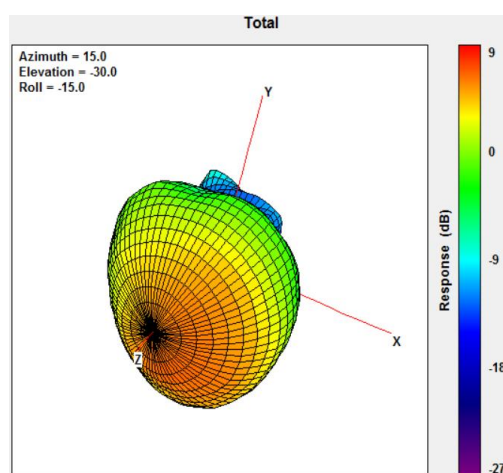

2170MHz

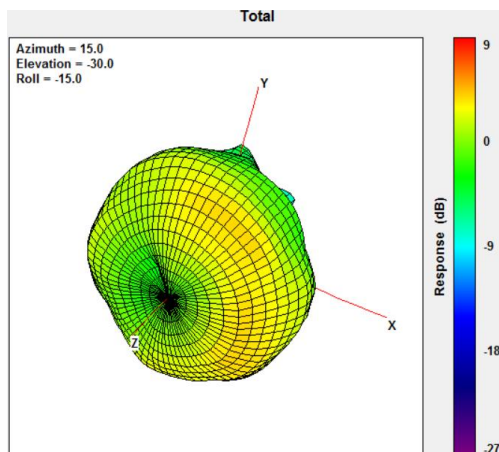

2690MHz

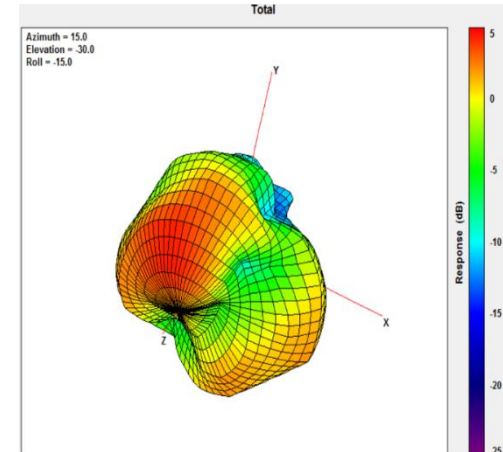

3500MHz

3.3.9 2D Radiation pattern (MIMO2 with 1M cable length on the 50*50 ground plane)

XY Plane

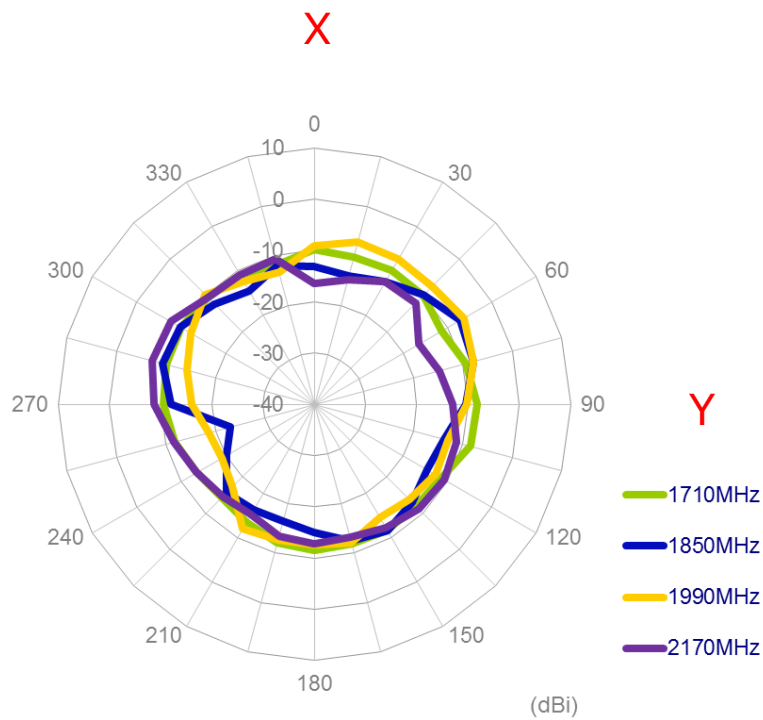
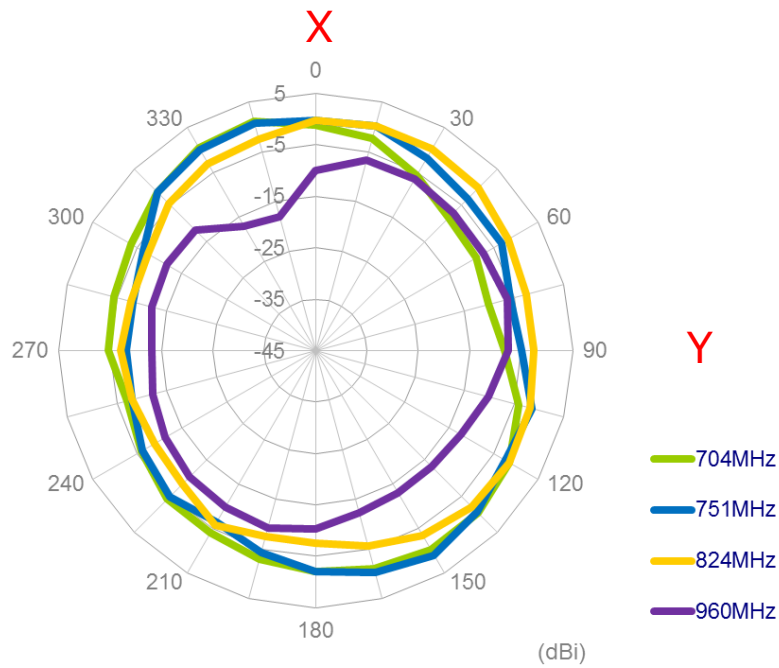

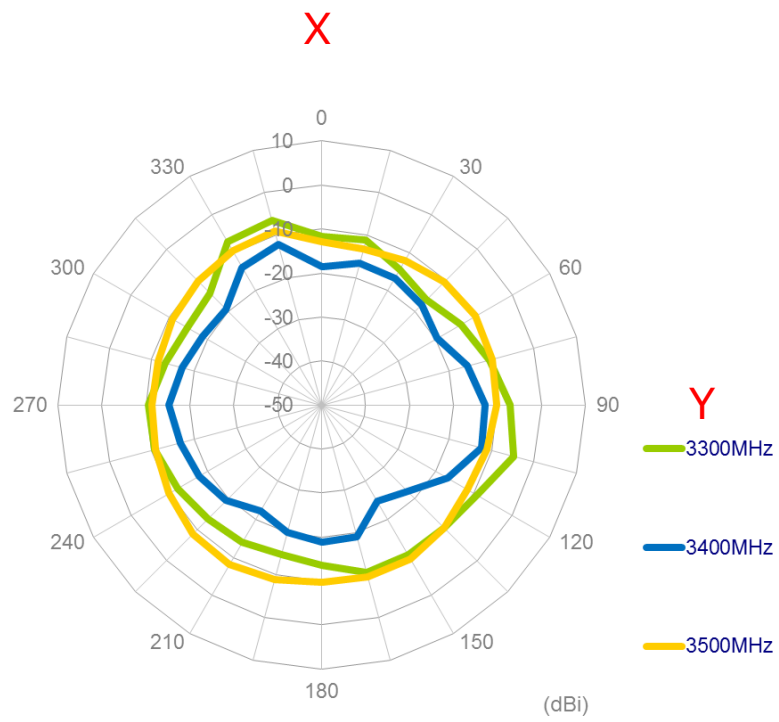
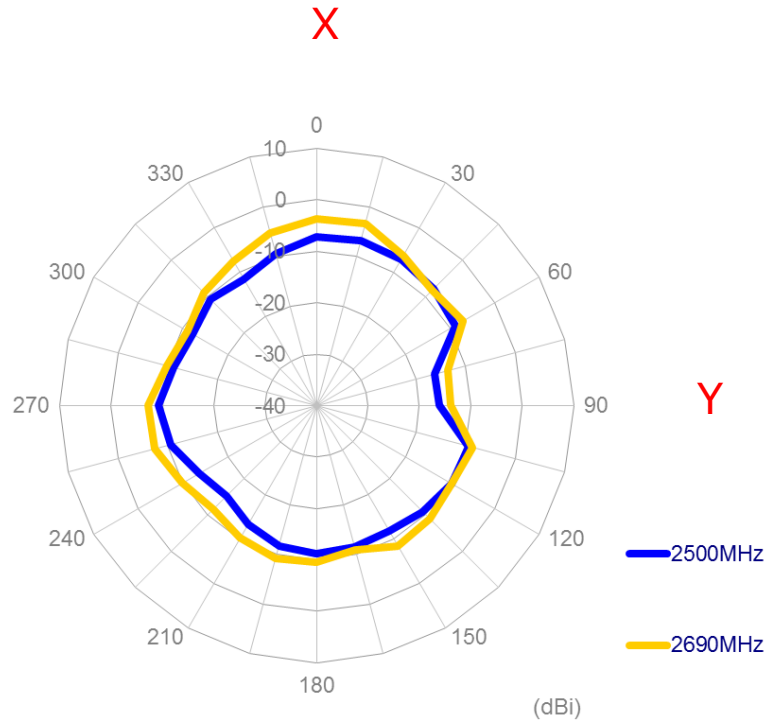

XZ Plane

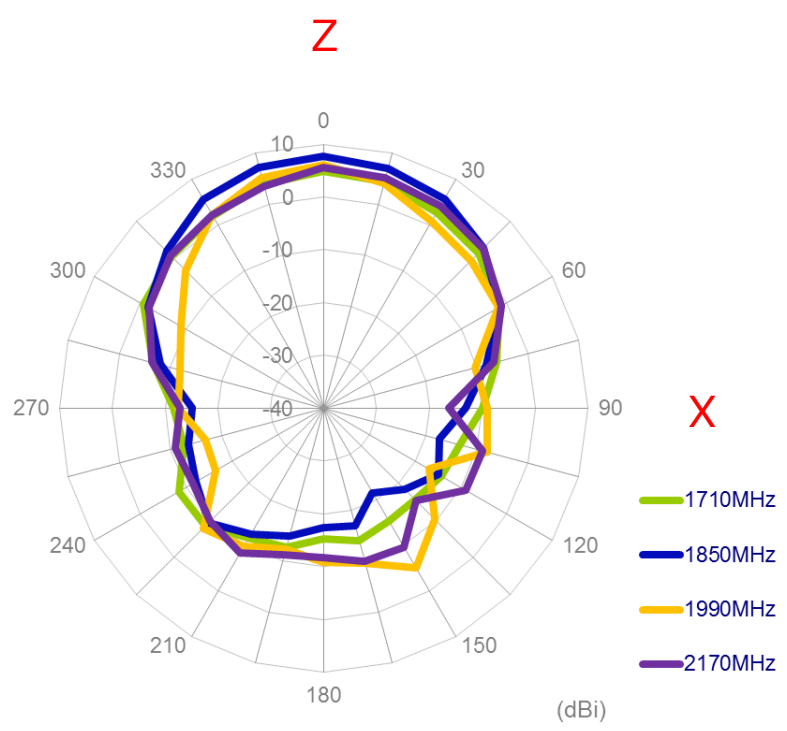
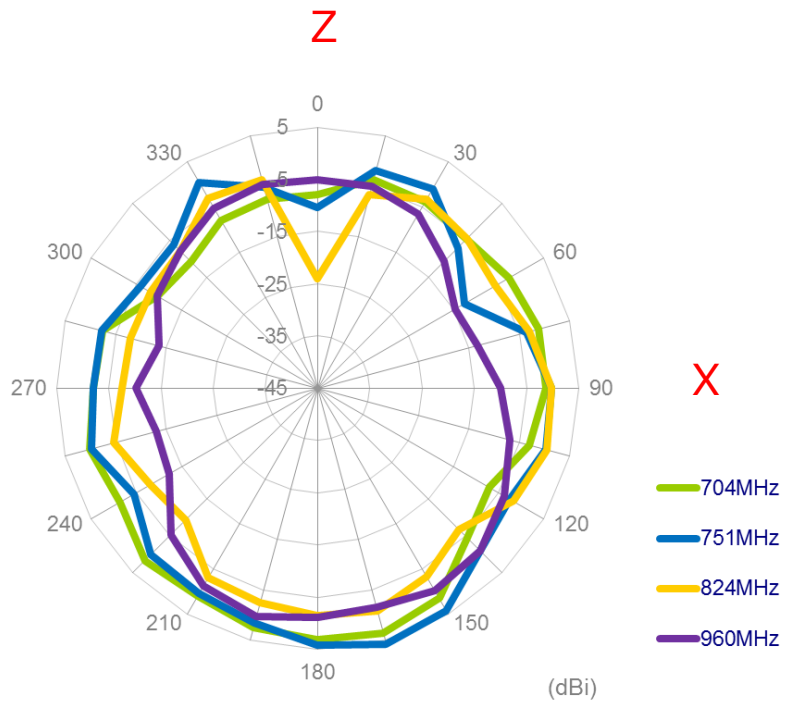

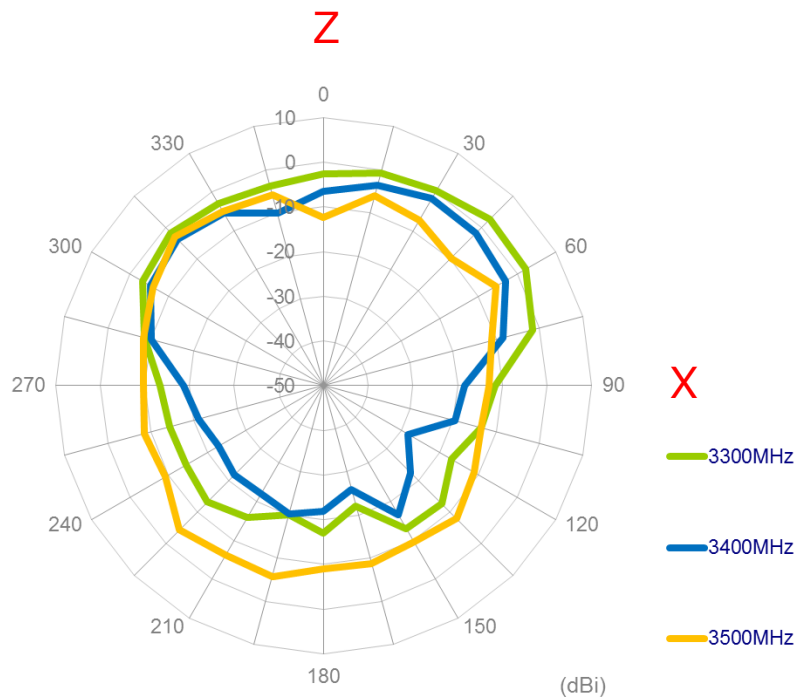
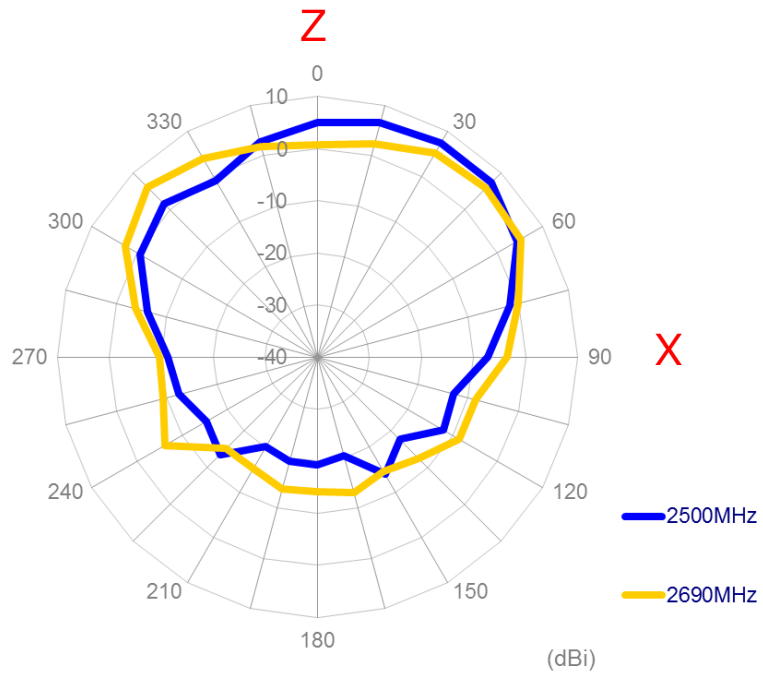

YZ Plane

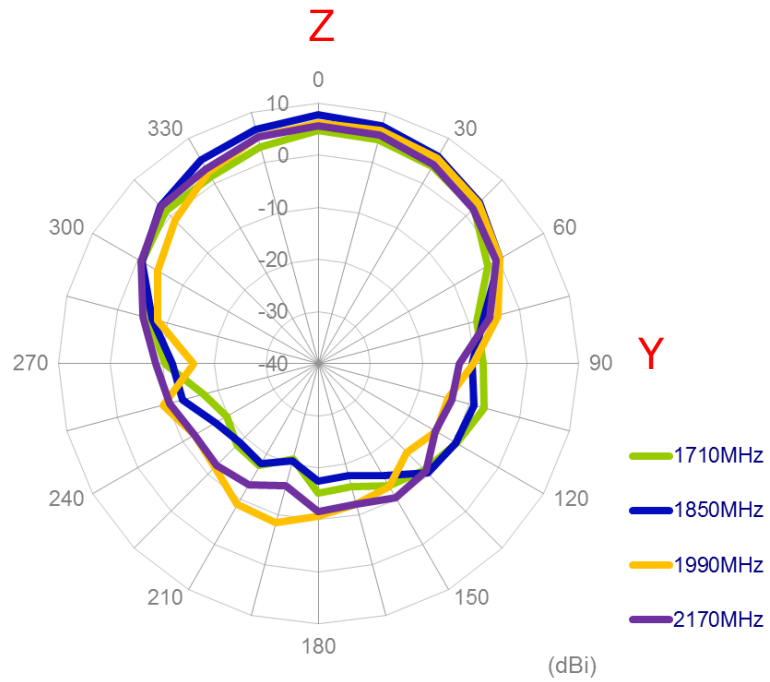
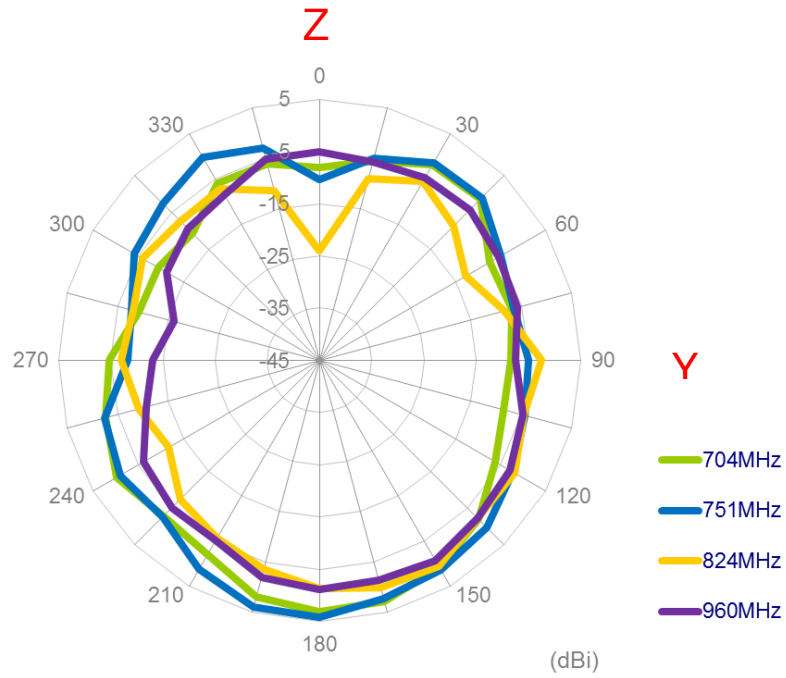

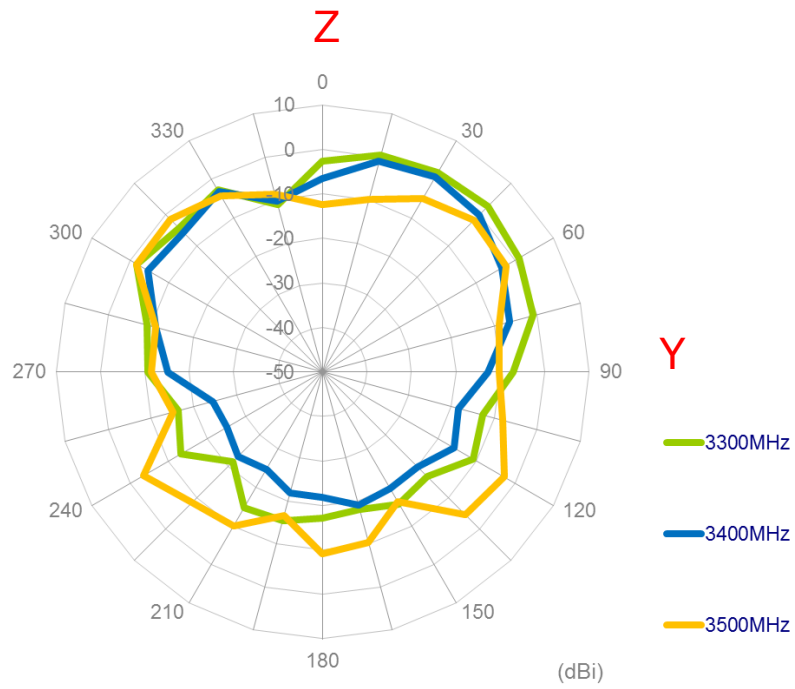
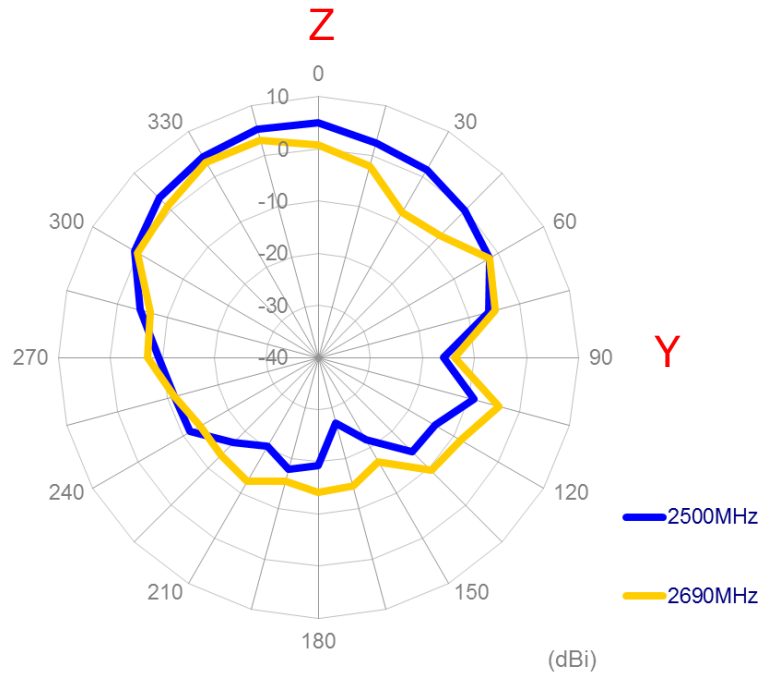

3.3.10 3D Radiation pattern (MIMO2 with 1M cable length on the 50*50 ground plane)

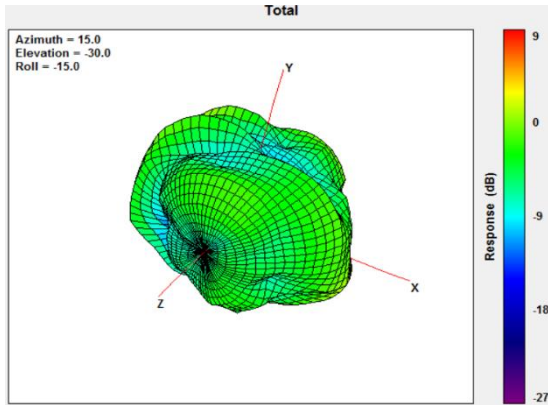

704MHz

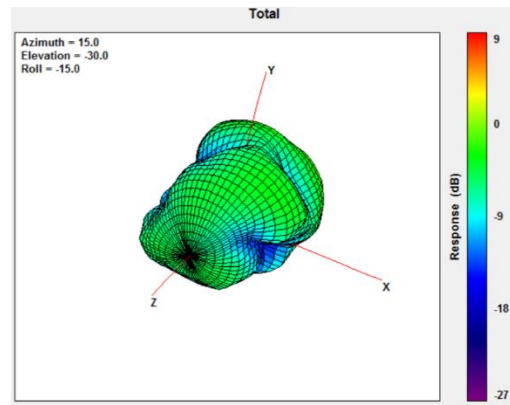

960MHz

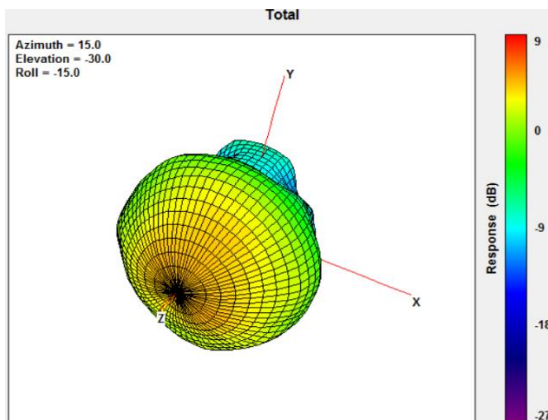

1710MHz

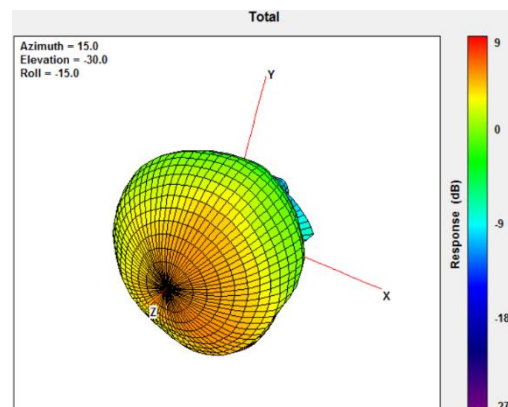

2170MHz

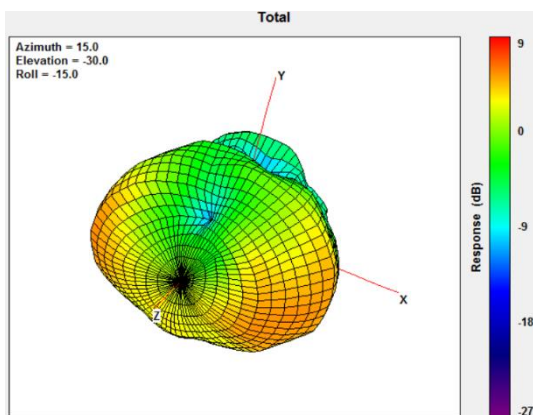

2690MHz

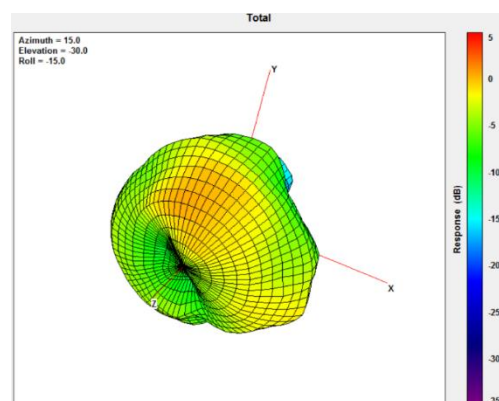

3500MHz

3.3.11 Test Setup for Antenna Radiation Pattern (ETS Anechoic chamber)

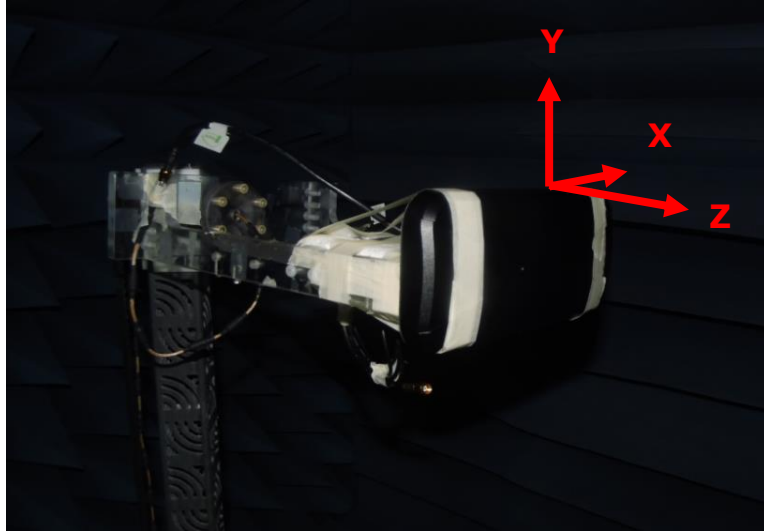

In free space

3.3.12 2D Radiation pattern (MIMO1 with 1M cable length in free space)

XY Plane

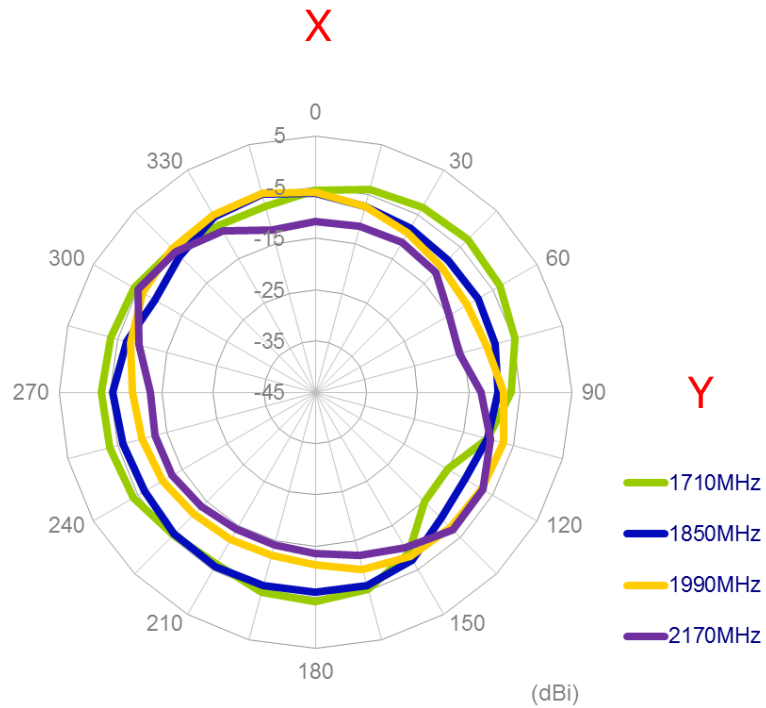
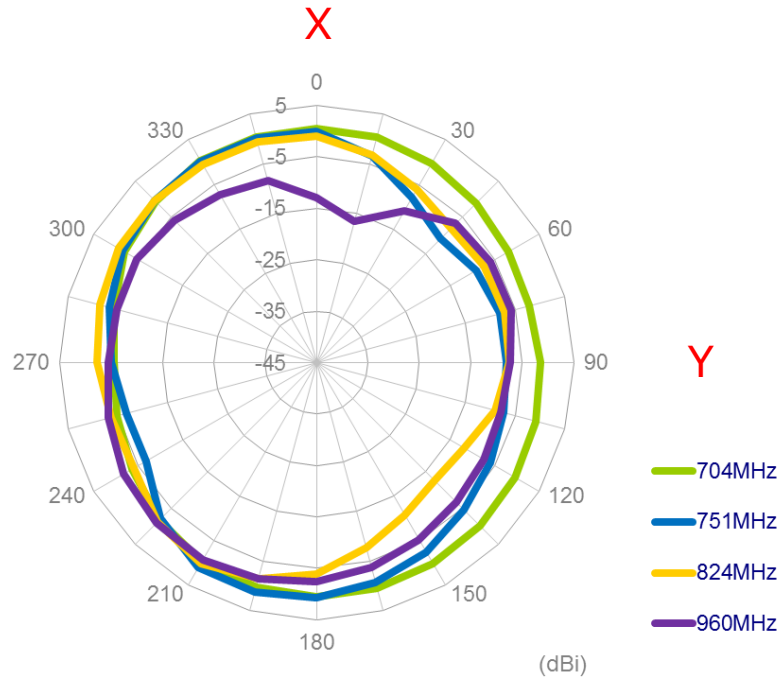

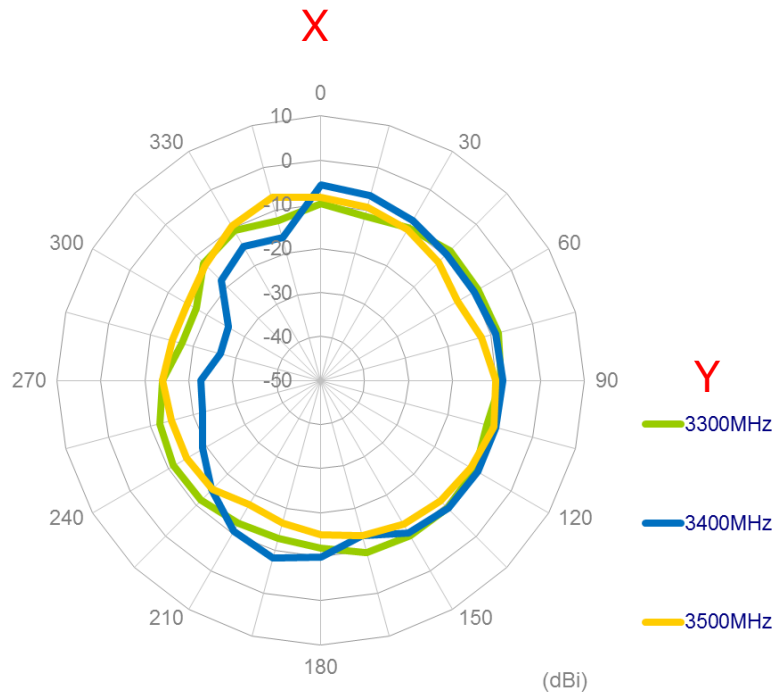
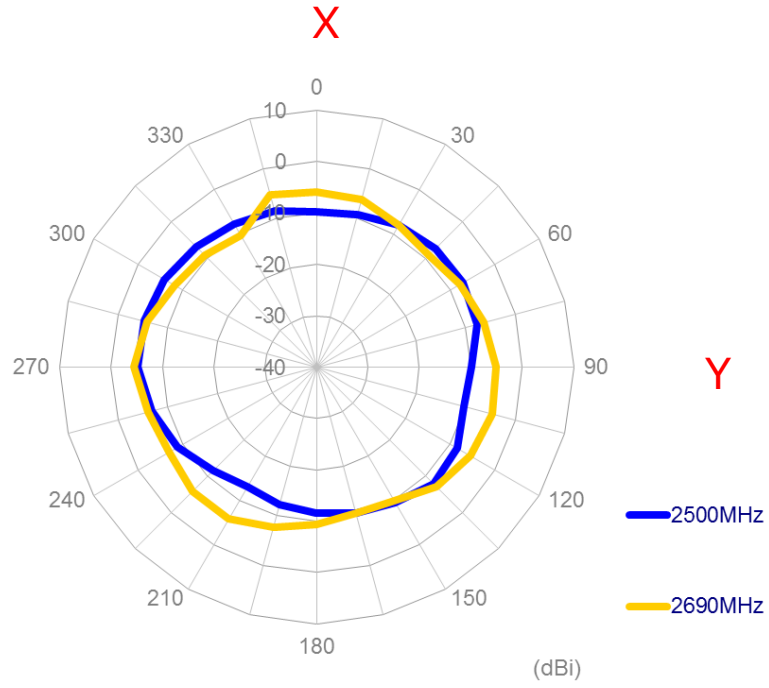

XZ Plane

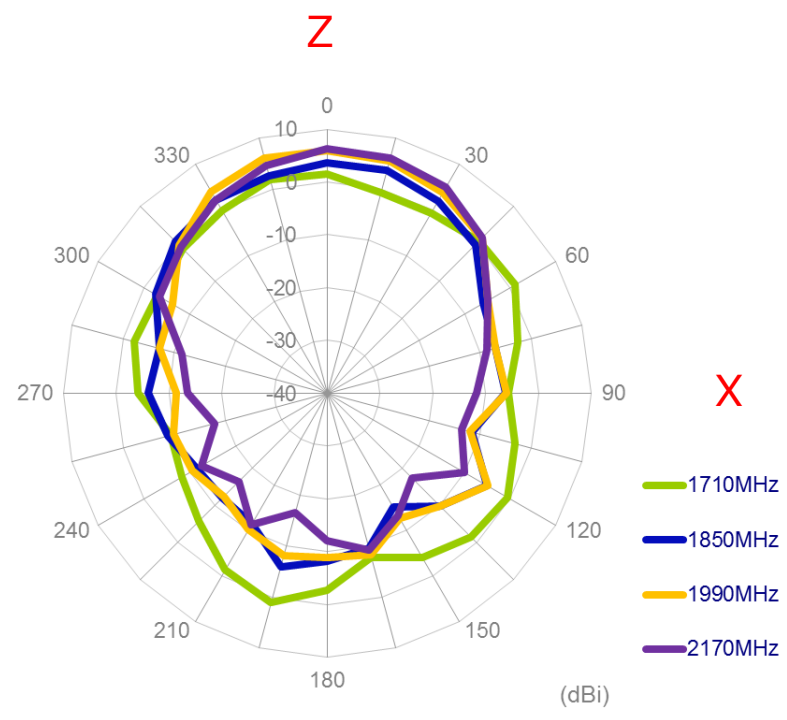
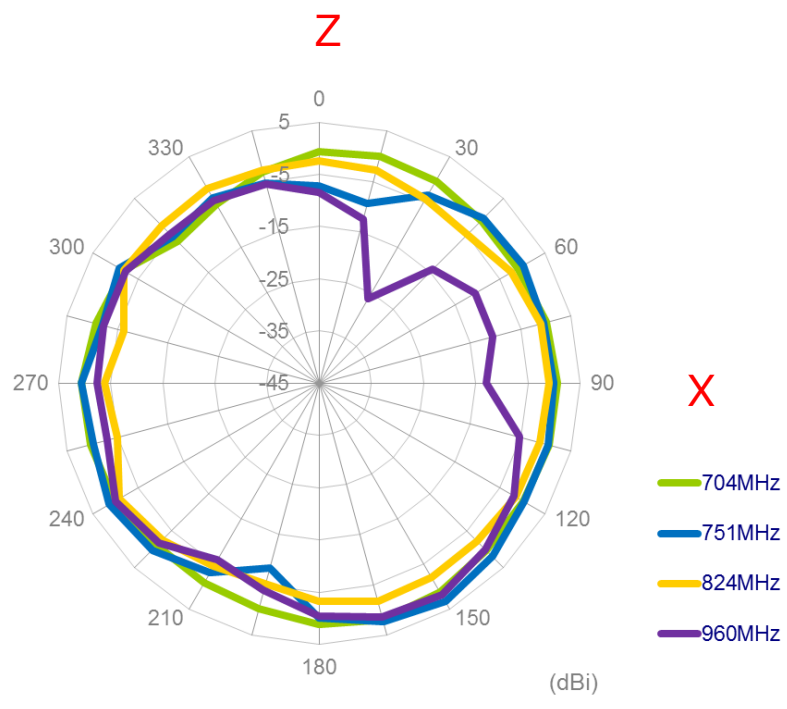

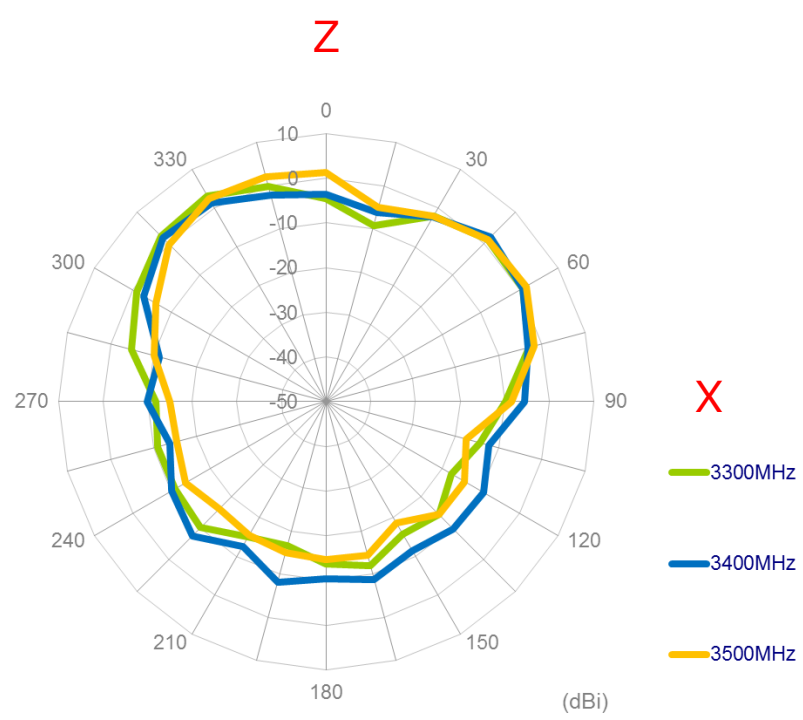
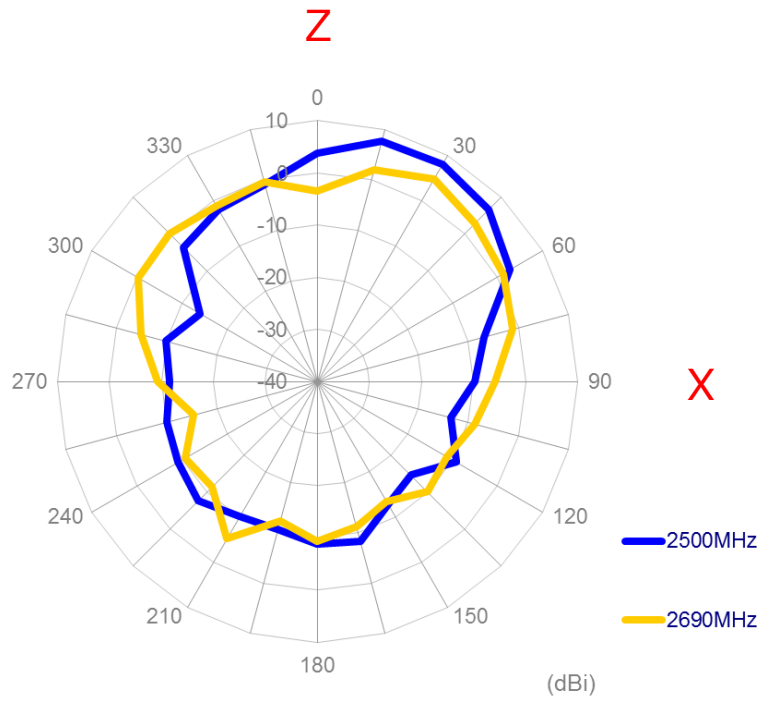

YZ Plane

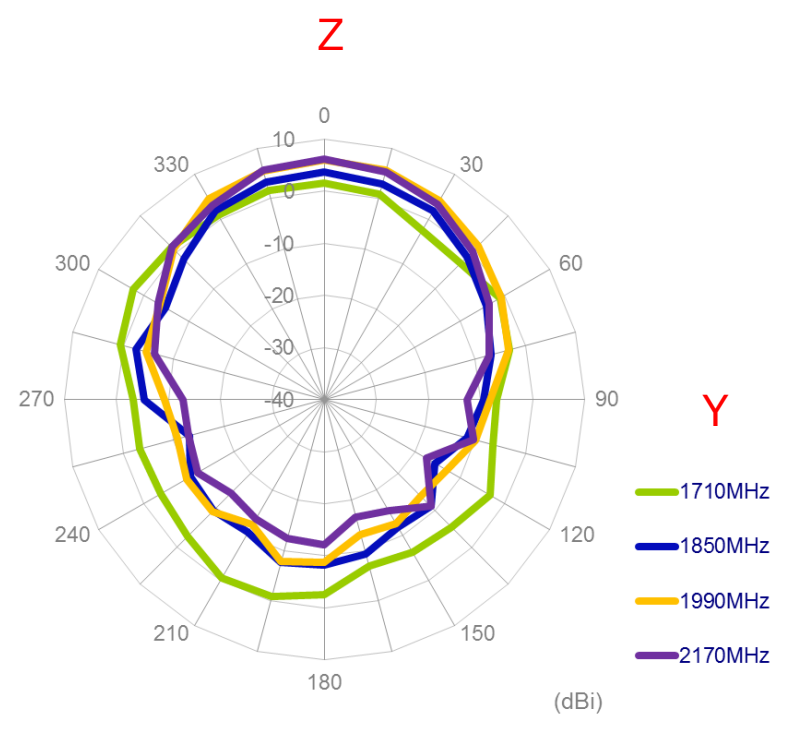
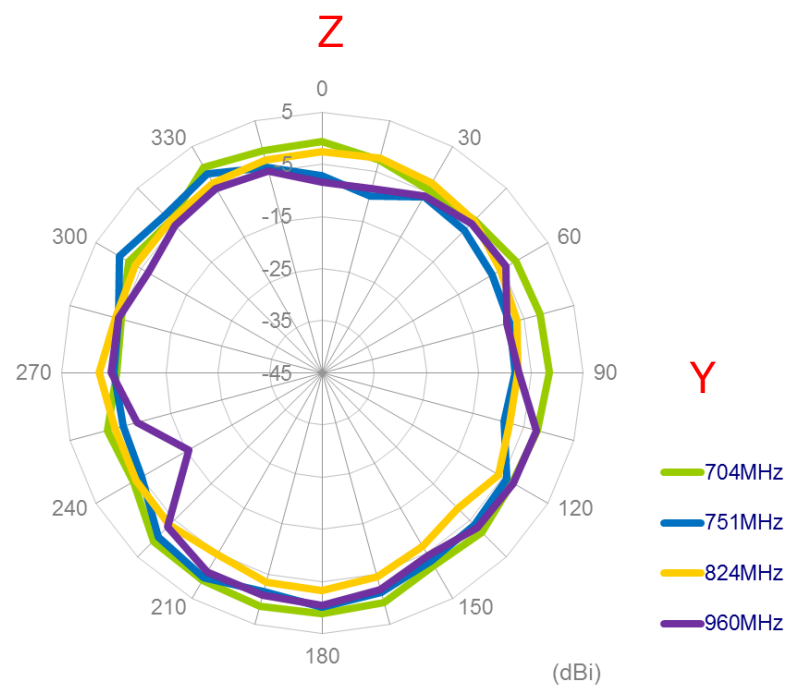

Z

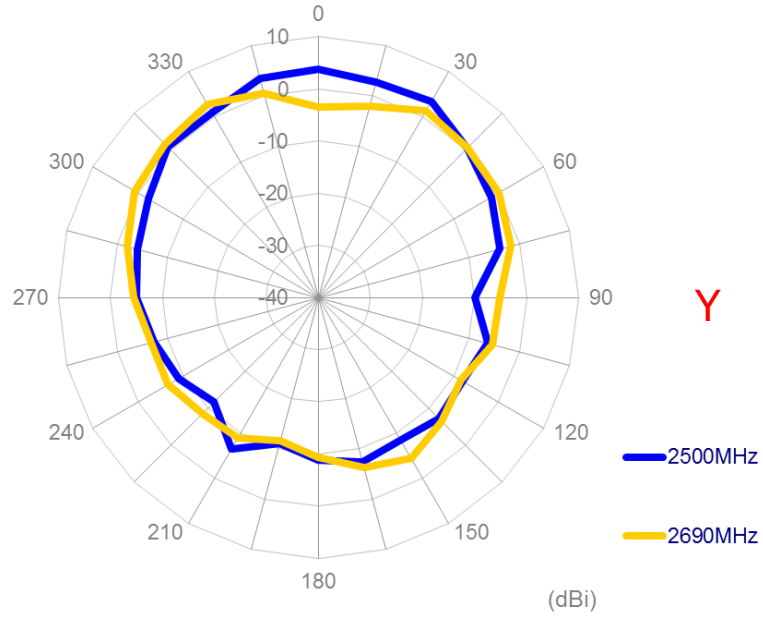

Z

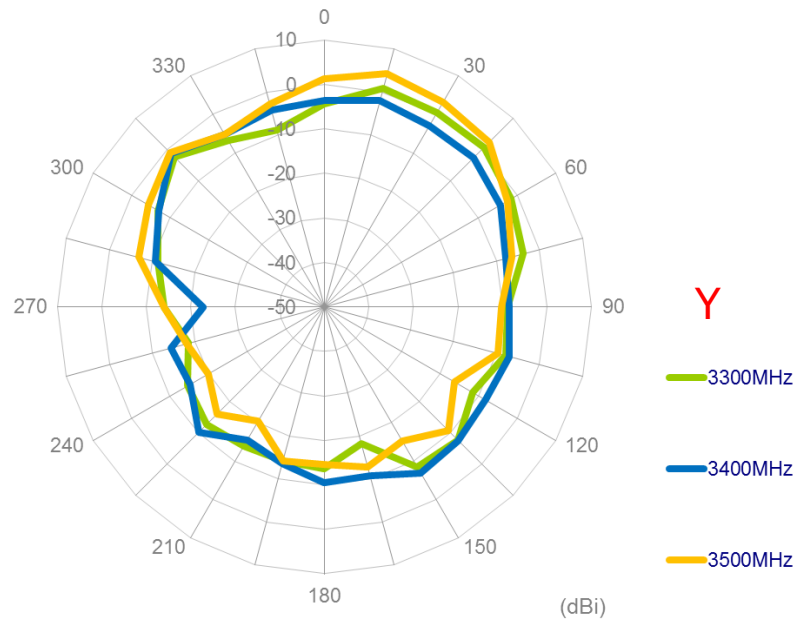

3.3.13 3D Radiation pattern (MIMO1 with 1M cable length in free space)

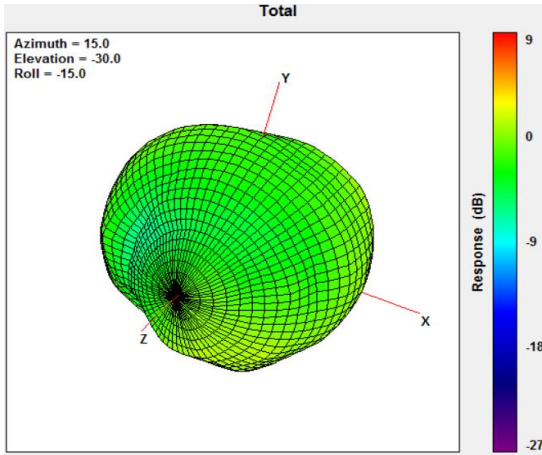

704MHz

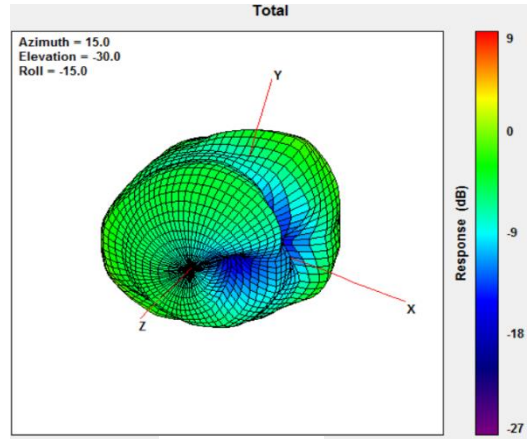

960MHz

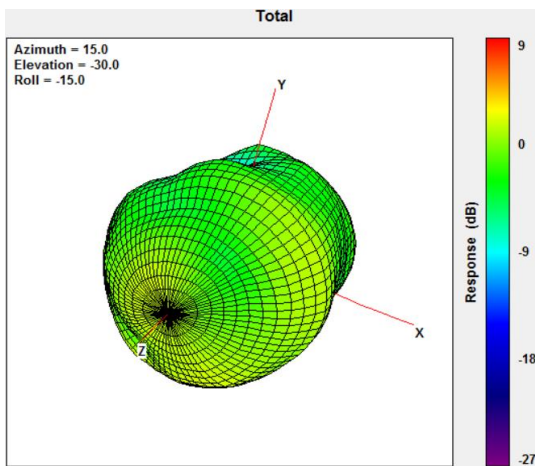

1710MHz

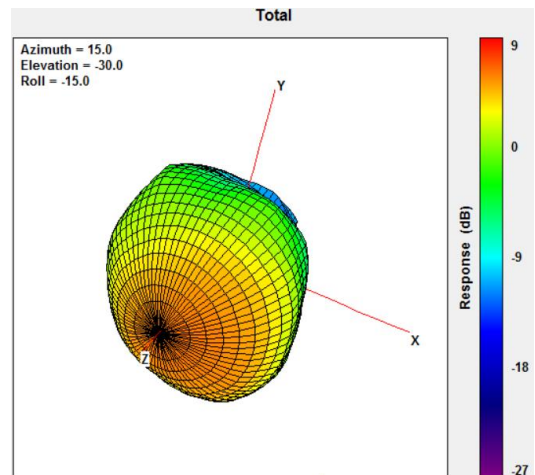

2170MHz

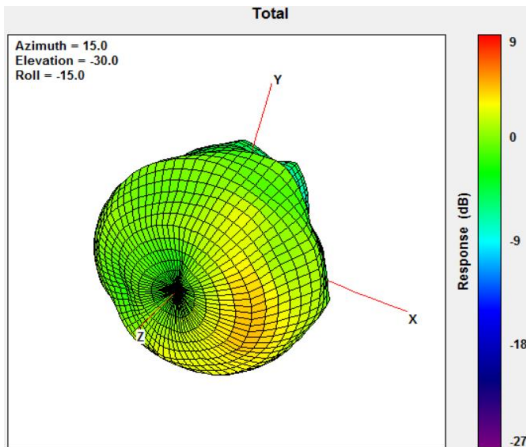

2690MHz

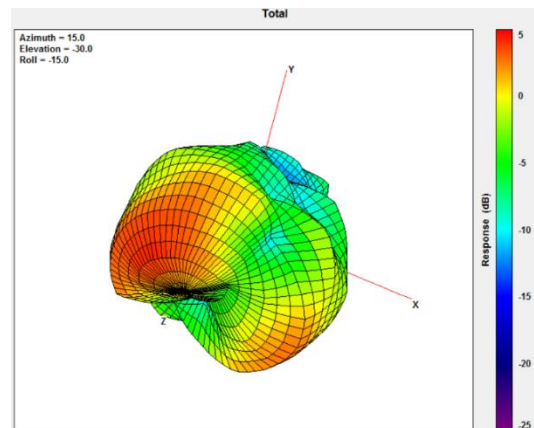

3500MHz

3.3.14 2D Radiation pattern (MIMO2 with 1M cable length in free space)

XY Plane

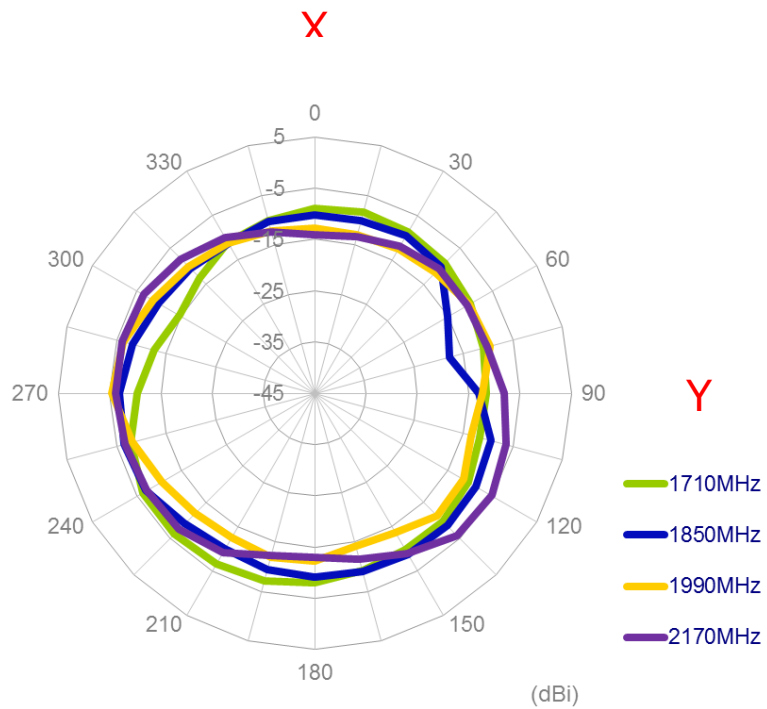
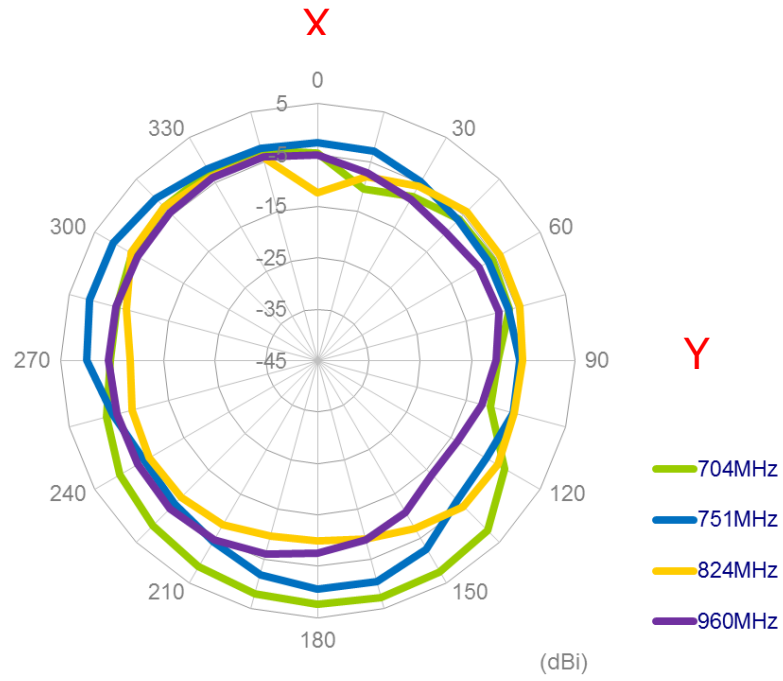

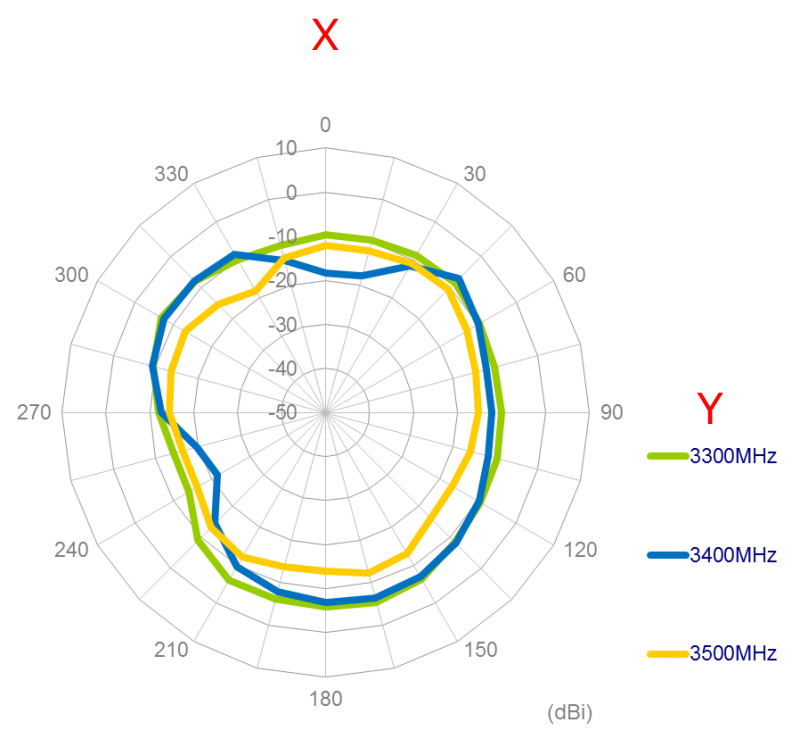
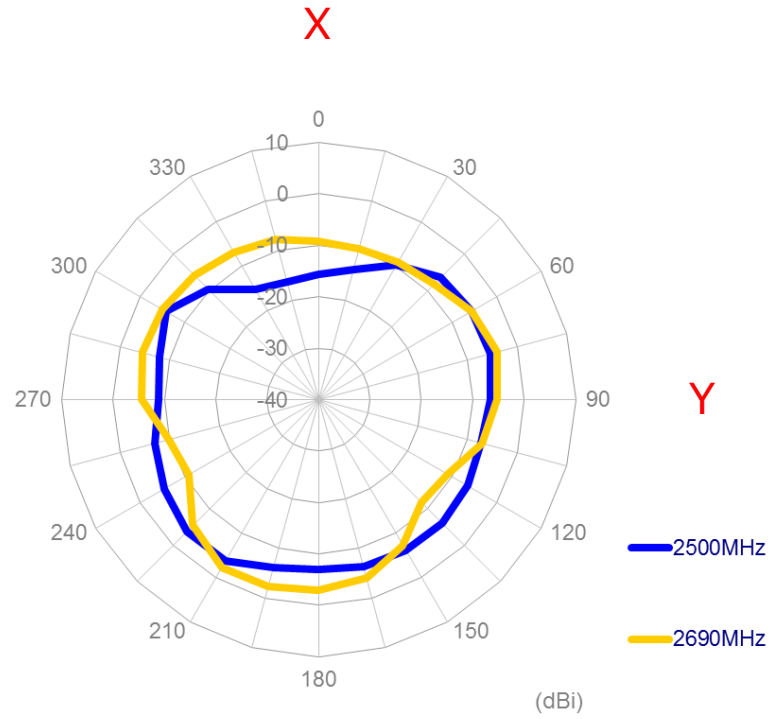

XZ Plane

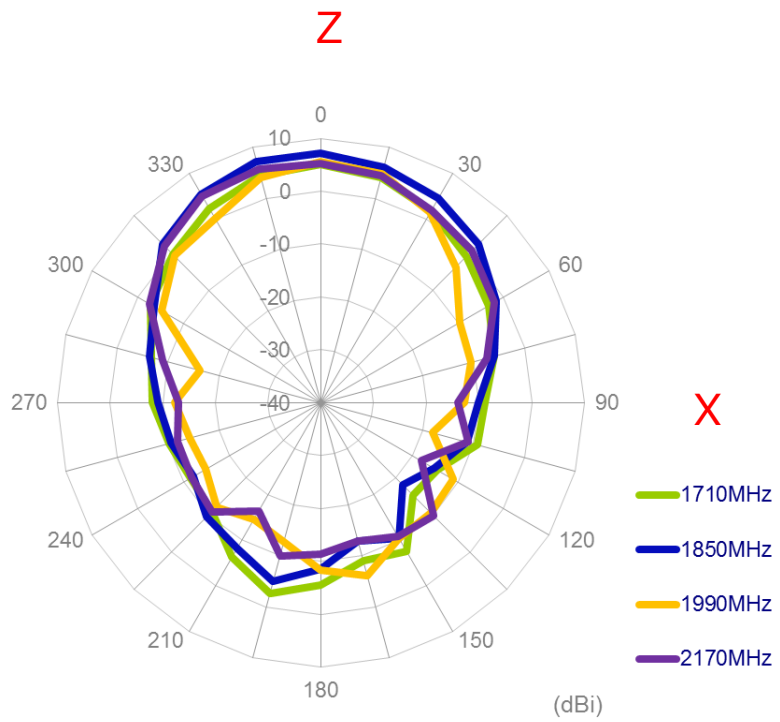
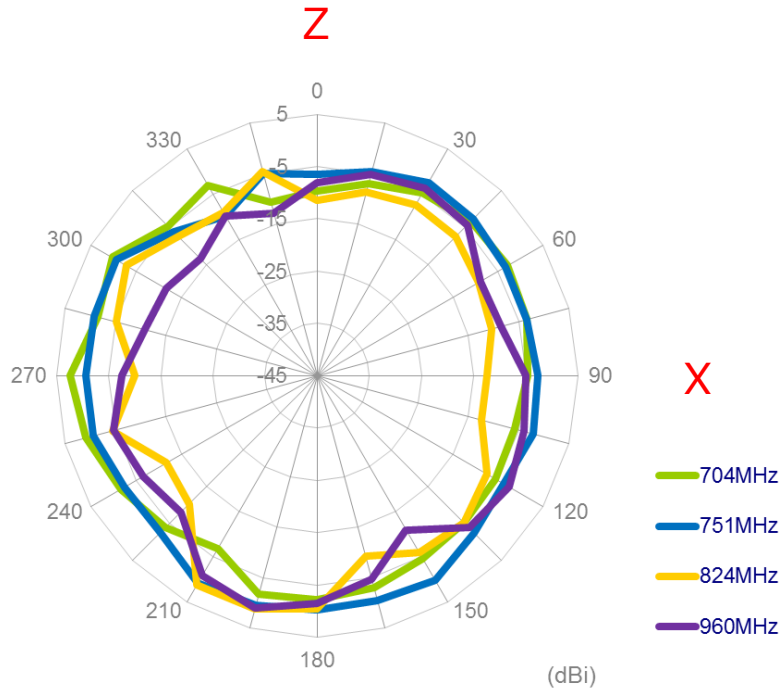

Z

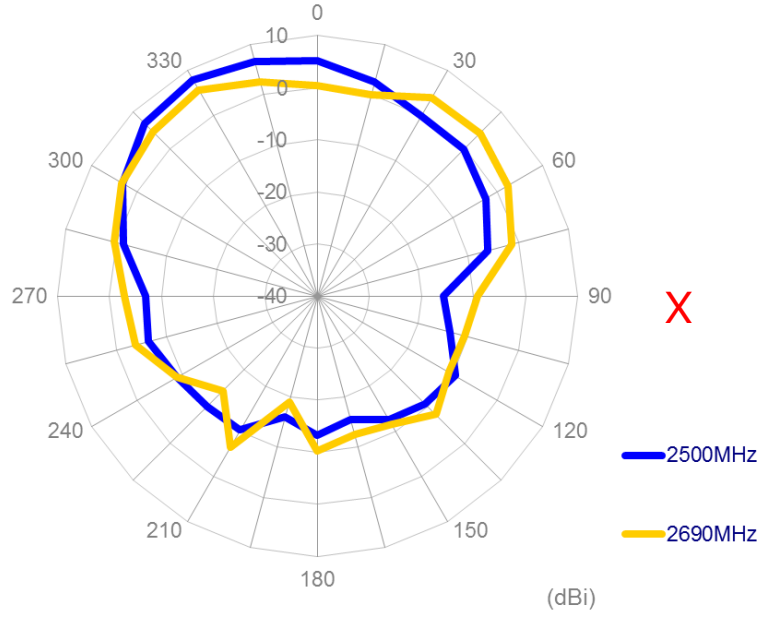

Z

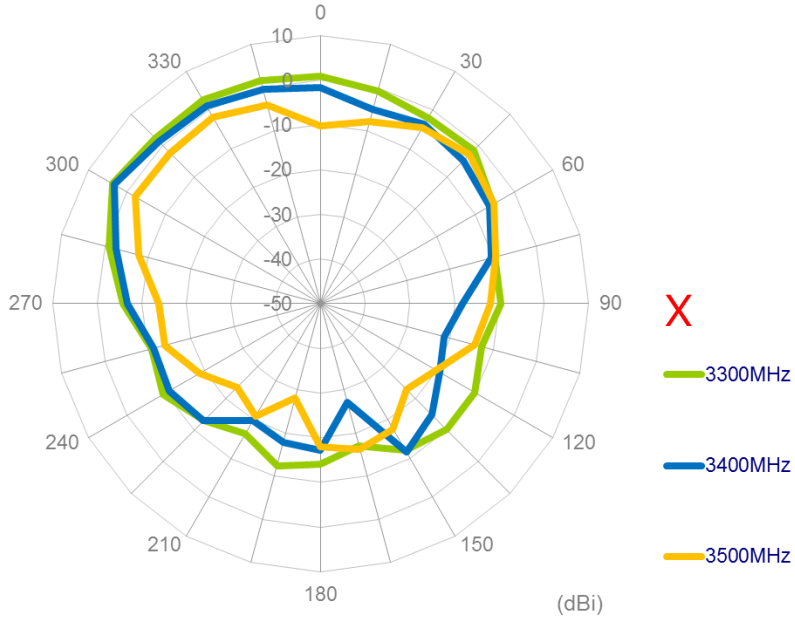

YZ Plane

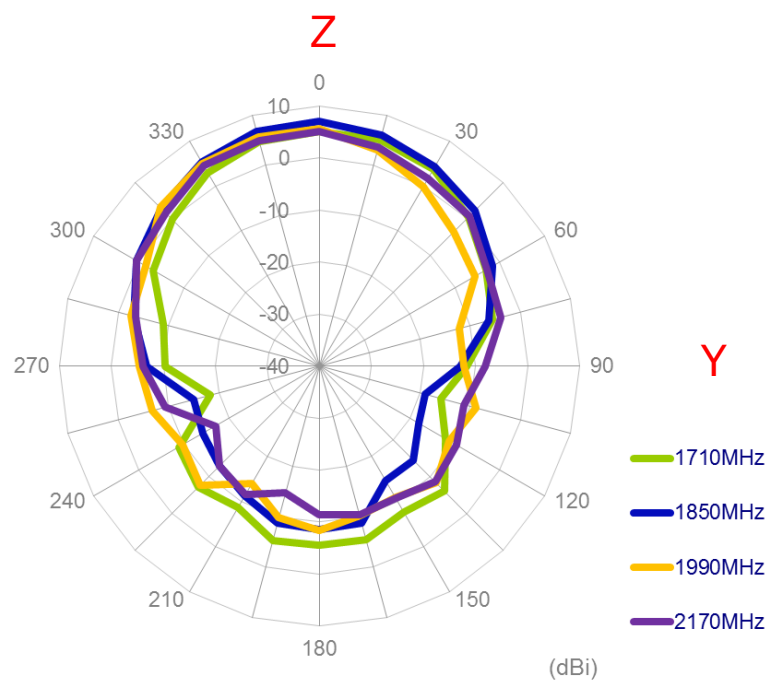
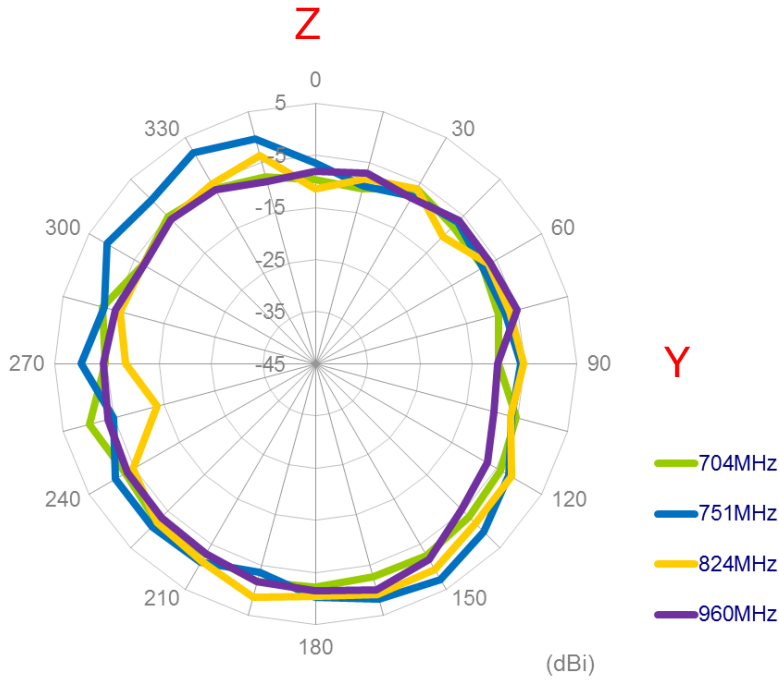

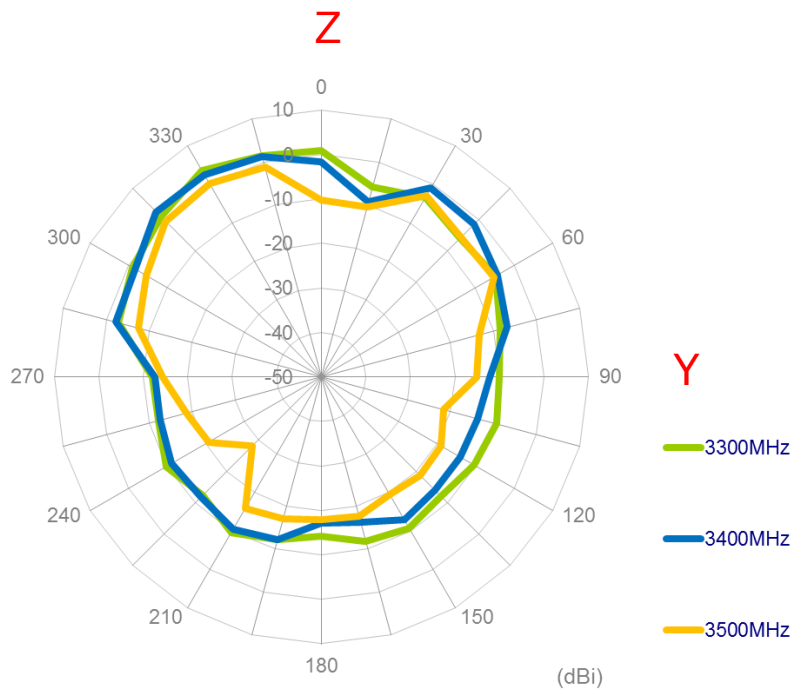
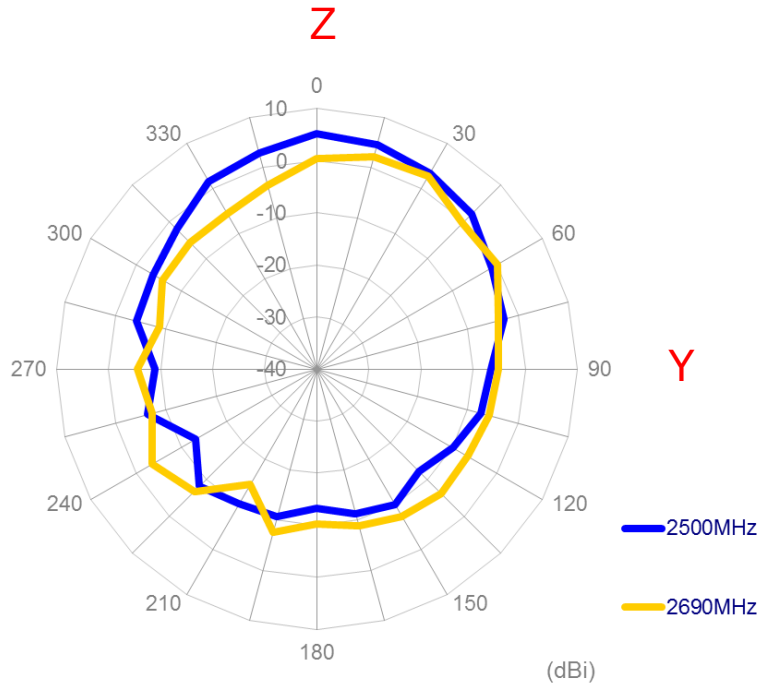

3.3.15 2D Radiation pattern (MIMO2 with 1M cable length in free space)

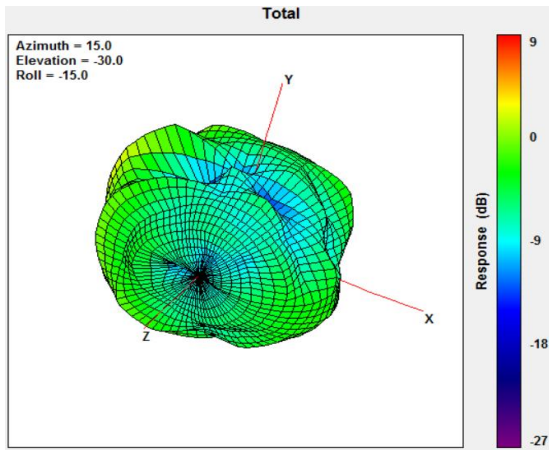

704MHz

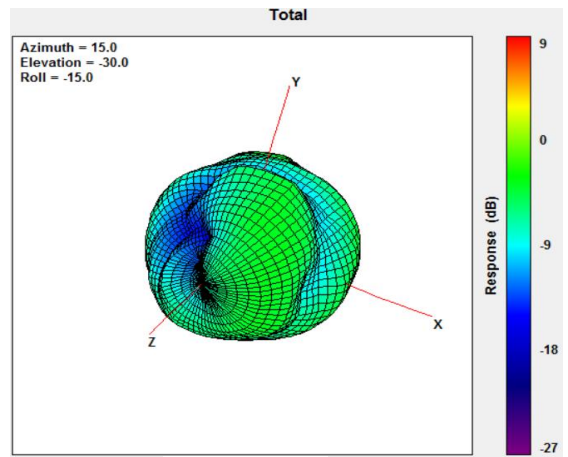

960MHz

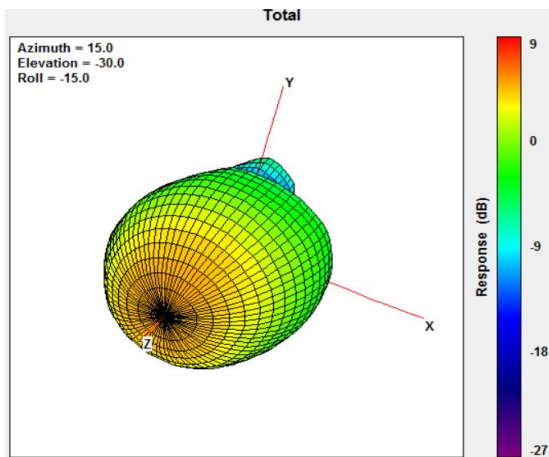

1710MHz

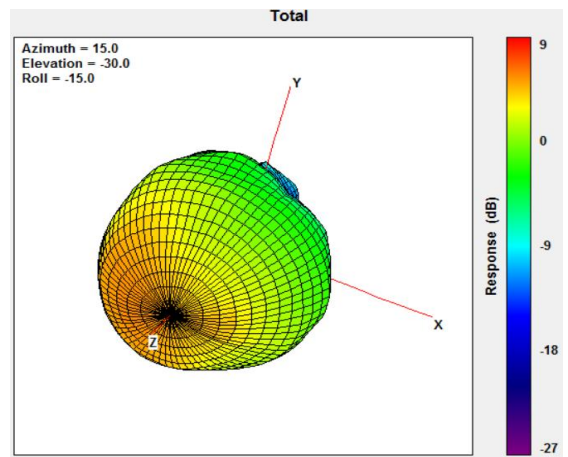

2170MHz

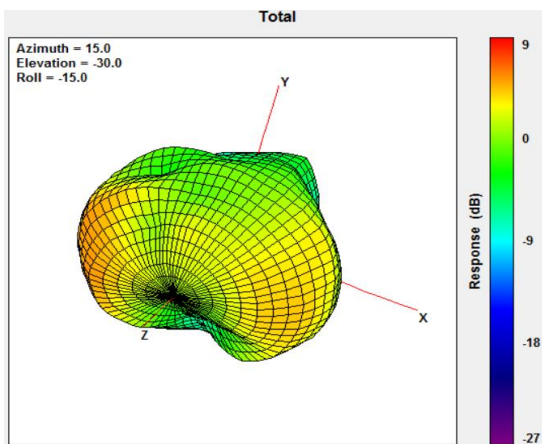

2690MHz

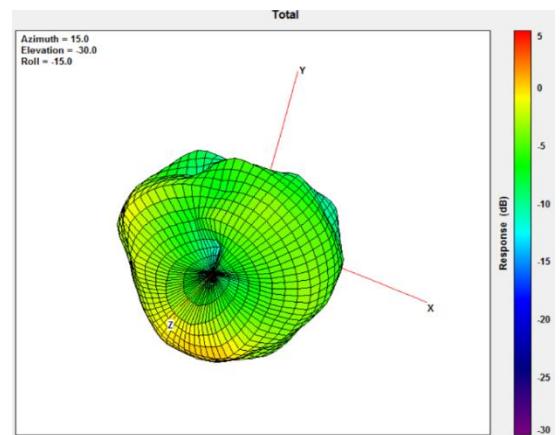

3500MHz

4. Mechanical Drawing (Unit: mm)

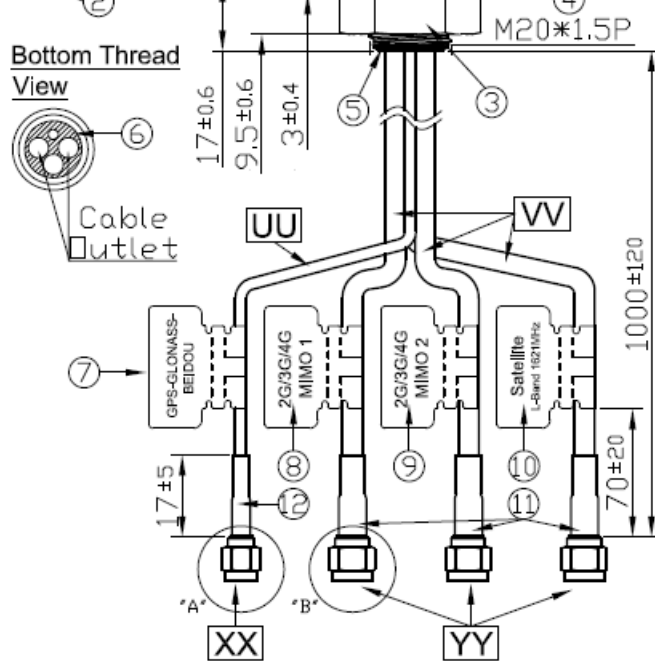
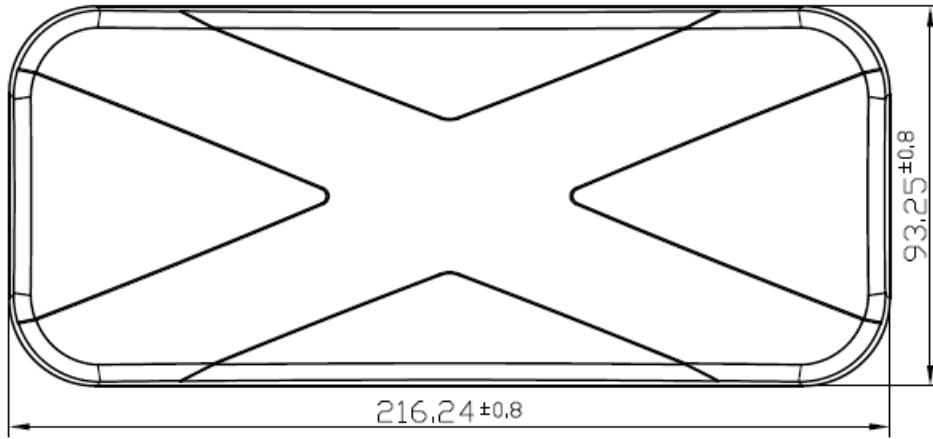

Name	P/N	Material	Finish	QTY
1 Housing	000113K000066A	ABS+PC	Black	1
2 Closed Cell Foam and Adhesive Tape	001013K000039A	3M 9448+CR-4305	Black	1
3 Nut_M20x1.5Px10H Cut	000413E030061A	Steel	NI Plated	1
4 Washer_Cut	000413E040061A	Steel	NI Plated	1
5 Metal Base	000313K000060A	AL	NI Plated	1
6 Cable Rubber	000713E000063A	Silicone Rubber	Black	1
7 GPS-Glonass-BEIDOU Label	001014E030051A	Coated Paper	Orange	1
8 2G/3G/4G MIMO1 Label	001012L080051A	Coated Paper	Gray	1
9 2G/3G/4G MIMO2 Label	001012L090051A	Coated Paper	White	1
10 L-Band Label	001014I000051A	Coated Paper	Moccasin	1
11 Heat Shrink Tube	001311F010013A	PE	Black	3
12 Heat Shrink Tube	001311F000013A	PE	Black	1

Name	P/N	Spec	Finish	QTY
UU Cable Type	301313A000013A	RG174	Black	1
VV Cable Type	301412K010013A	CFD200	Black	3
XX Connector Type	200212G000013A	SMA(M)ST	Gold	1
YY Connector Type	200214F000013A	SMA(M)ST	Gold	3

4.1 Connector Drawing (Unit: mm)

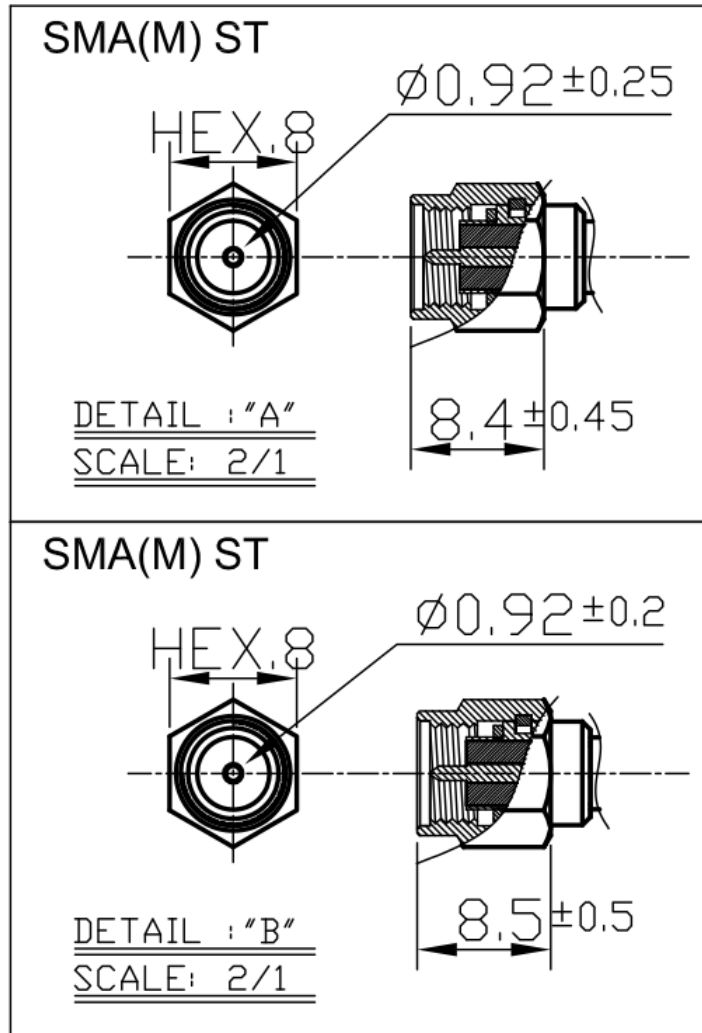

5. Installation

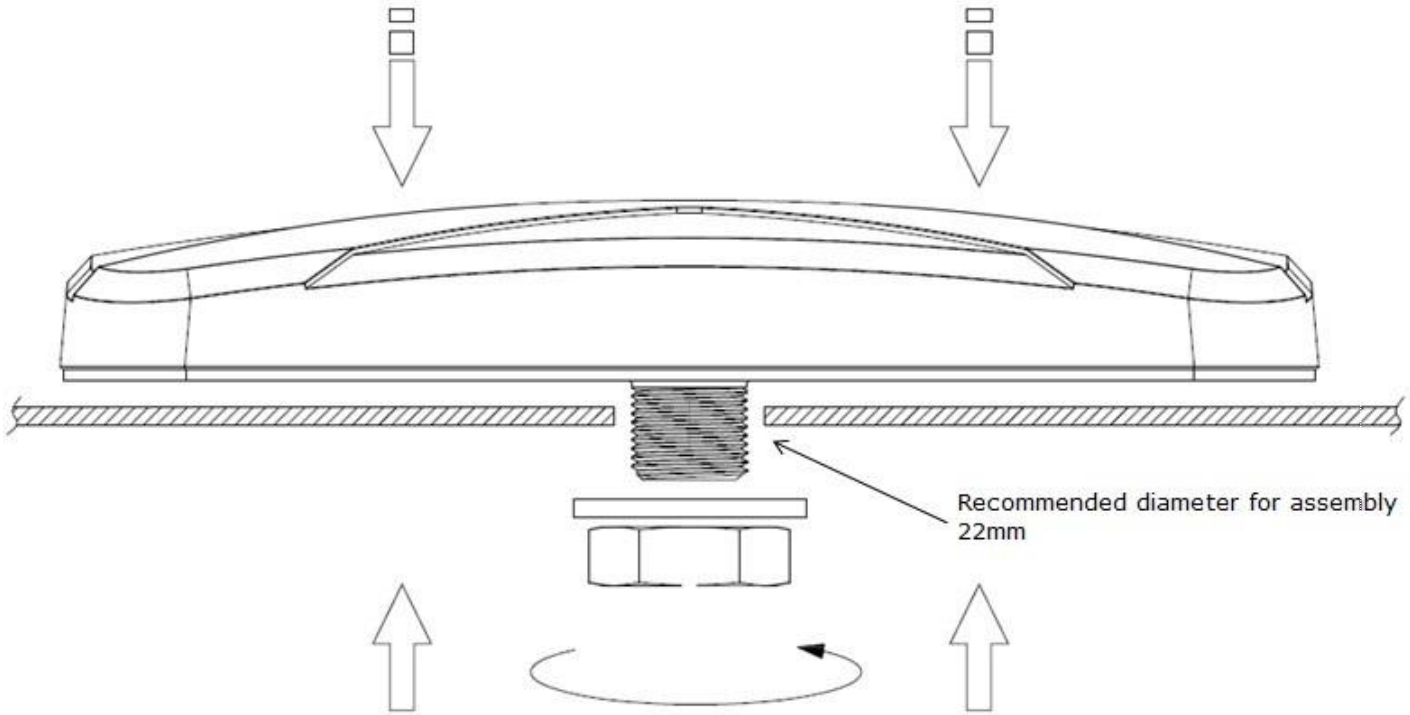

Recommended torque for mounting is 29.4 N.m
Maximum torque for mounting is 39.2 N.m

6. Packaging

MA410.A.LBIJ.001

Packaging Specifications

1pc MA410.A.LBIJ.001 per small box
 Box Dimensions - 95*330*105mm
 Weight - 700g

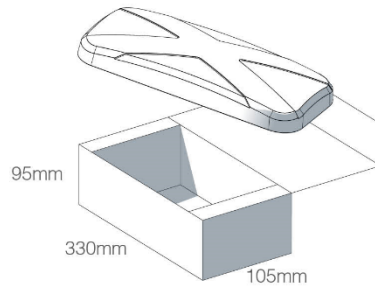

14 small boxes in one carton
 Carton Dimensions - 730*380*240mm
 Weight - 10.3Kg

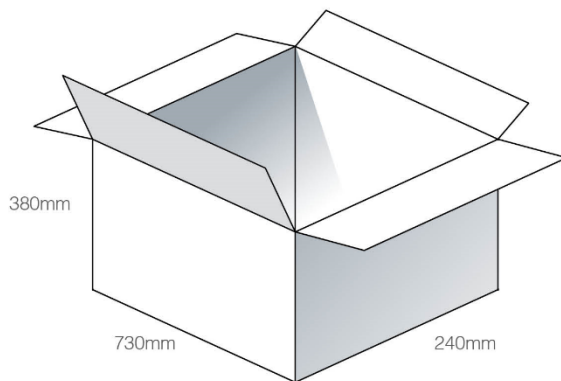

Pallet Dimensions 1100*1100*1590mm
 24 Cartons per Pallet
 4 Cartons per layer
 6 Layers

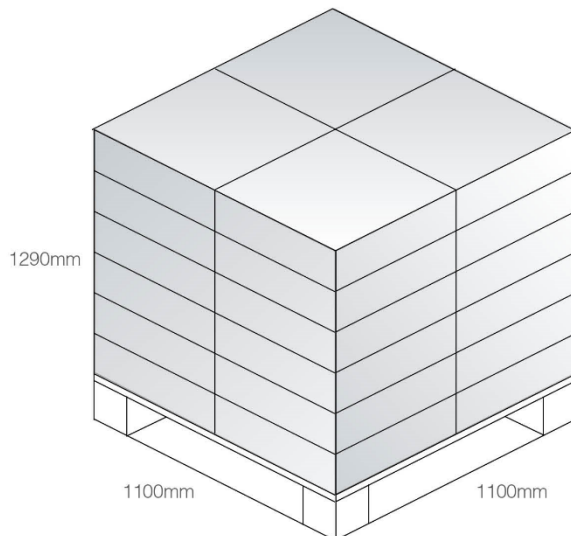

7. Application Note (LTE MIMO Antenna)

The MA410 antenna performance with different cable lengths and different environments is shown below.

7.1 On the 50*50cm ground plane

7.1.1 Return Loss (MIMO_1 on the 50*50cm ground plane)

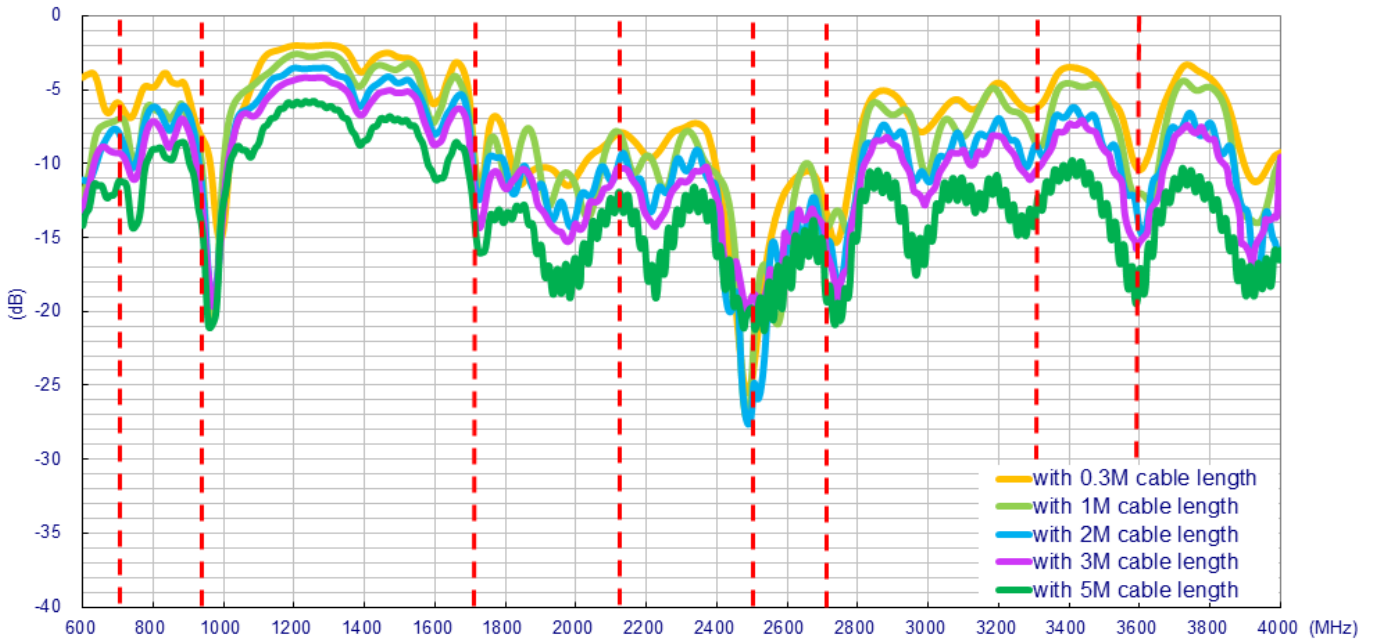

7.1.2 Return Loss (MIMO_2 on the 50*50cm ground plane)

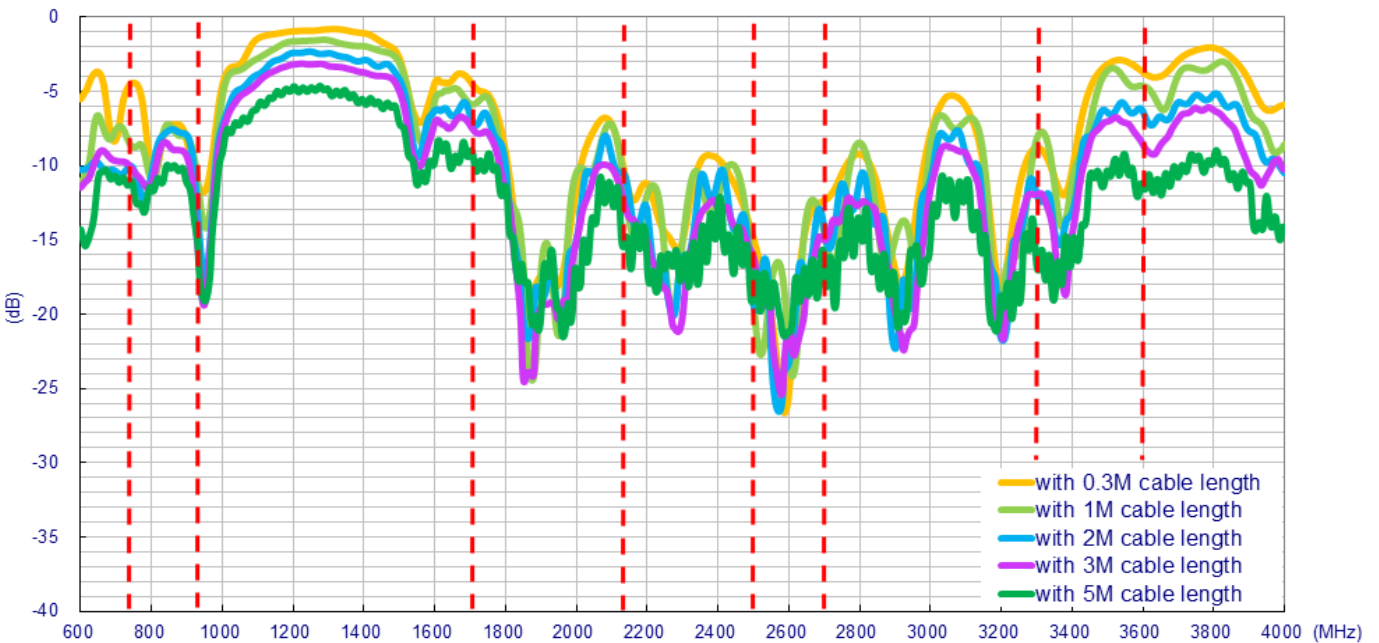

7.1.3 MIMO 1 & MIMO 2 Isolation (on the 50*50cm ground plane)

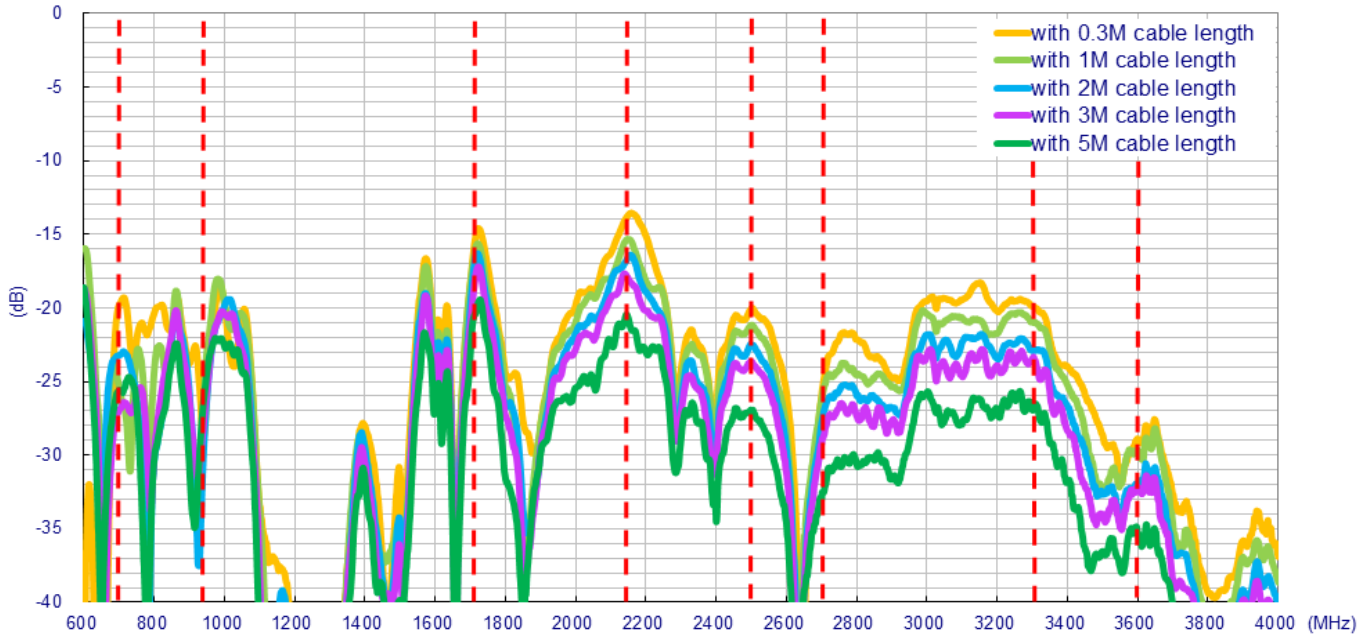

7.1.4 Efficiency (MIMO_1 on the 50*50cm ground plane)

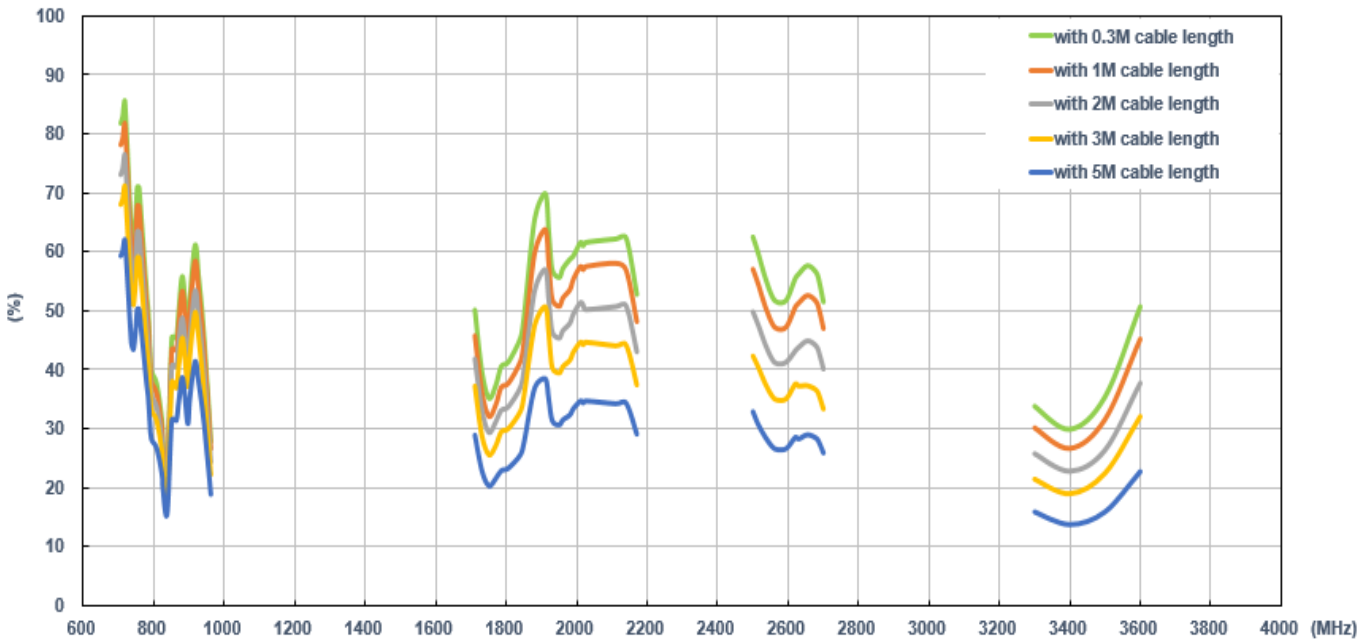

7.1.5 Efficiency (MIMO_2 on the 50*50cm ground plane)

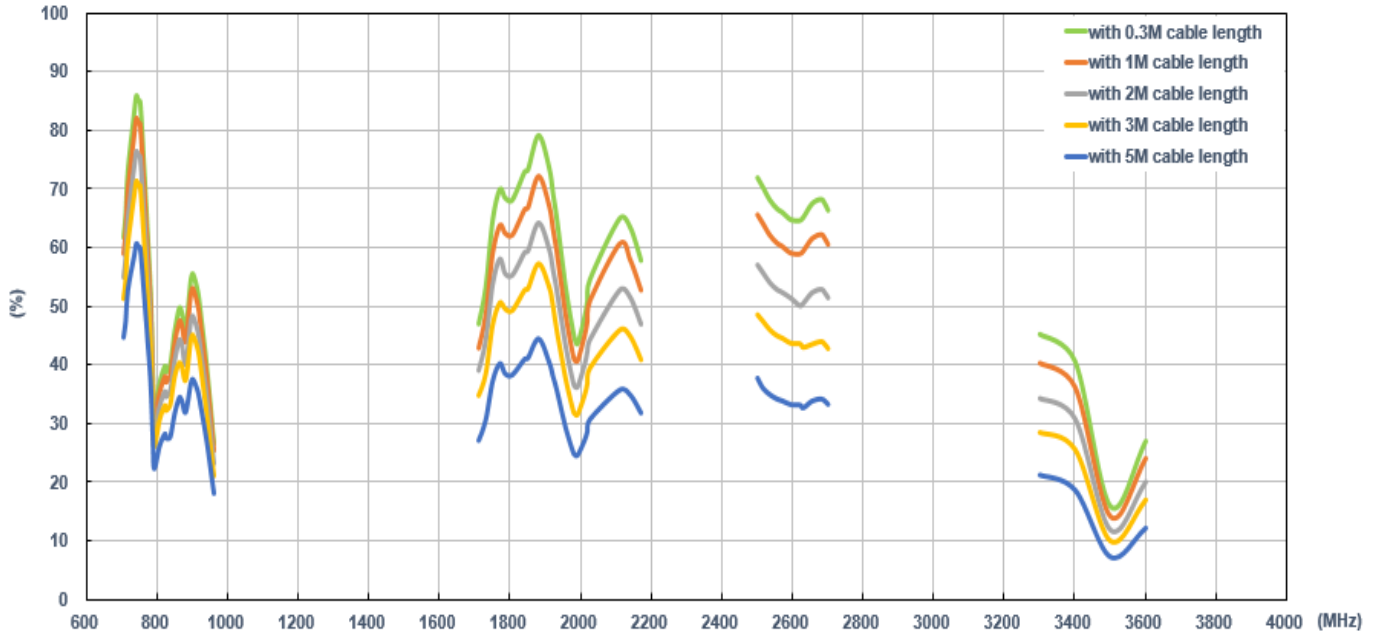

7.1.6 Average Gain (MIMO_1 on the 50*50cm ground plane)

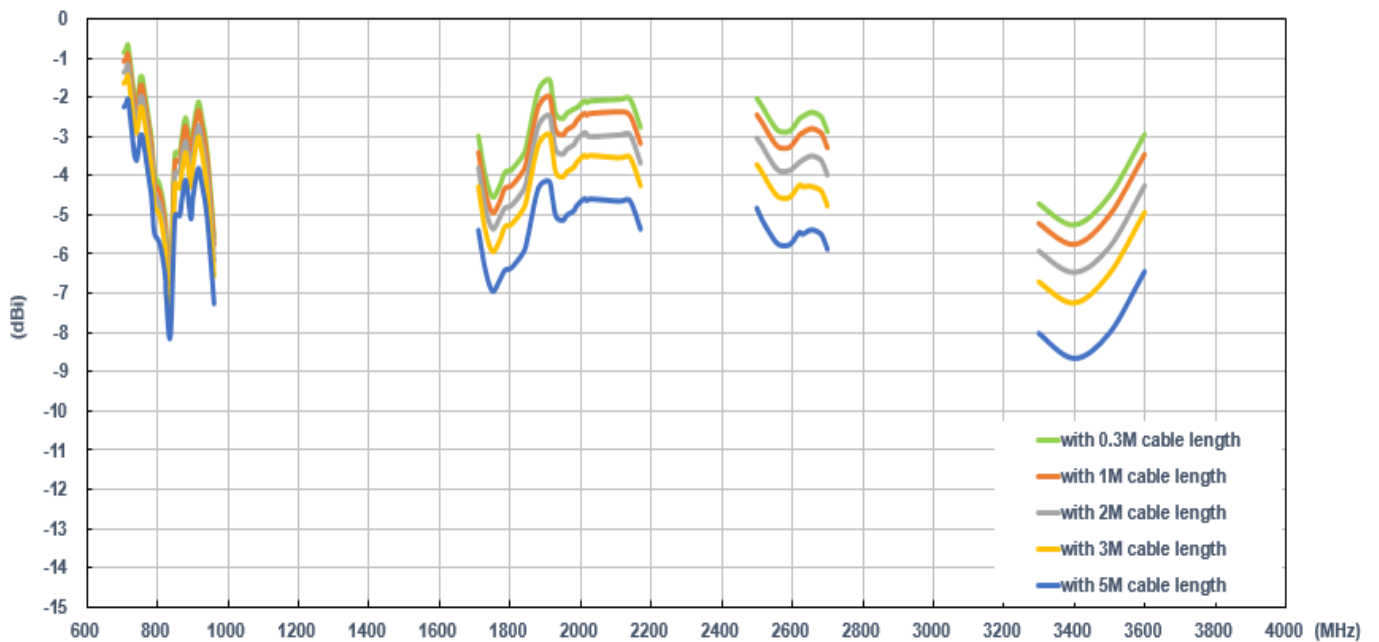

7.1.7 Average Gain (MIMO_2 on the 50*50cm ground plane)

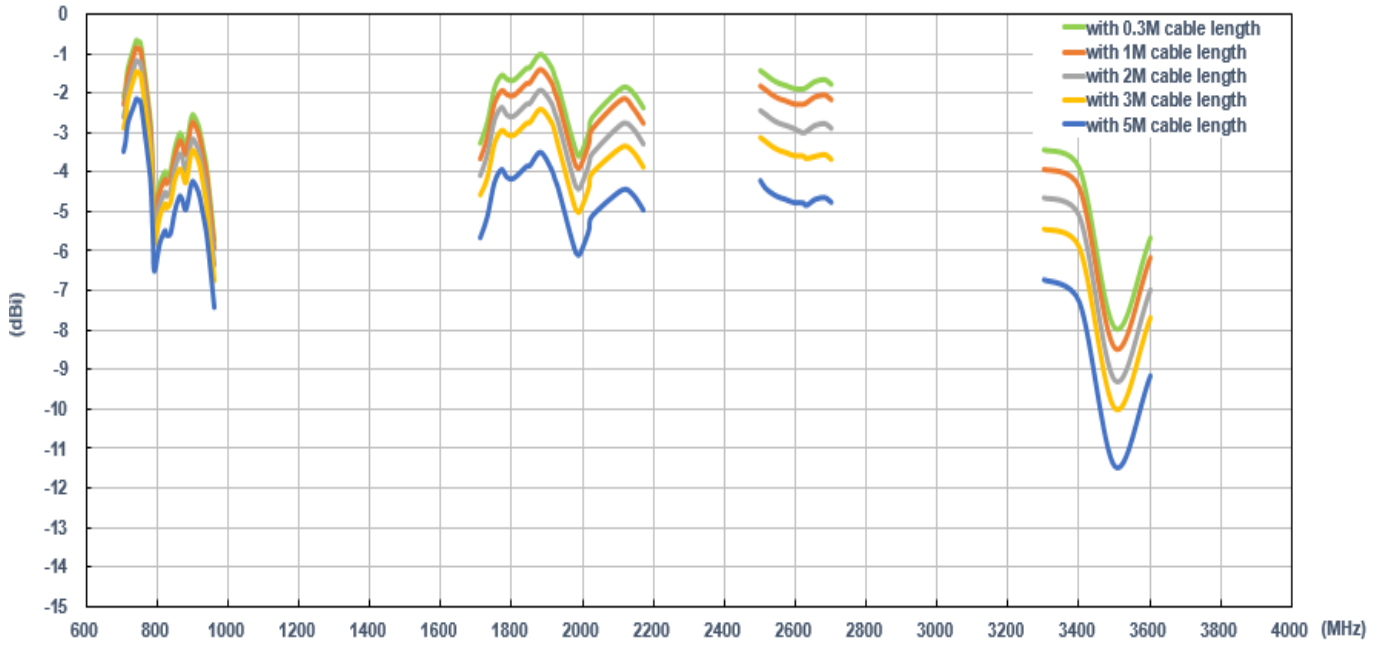

7.1.8 Peak Gain (MIMO_1 on the 50*50cm ground plane)

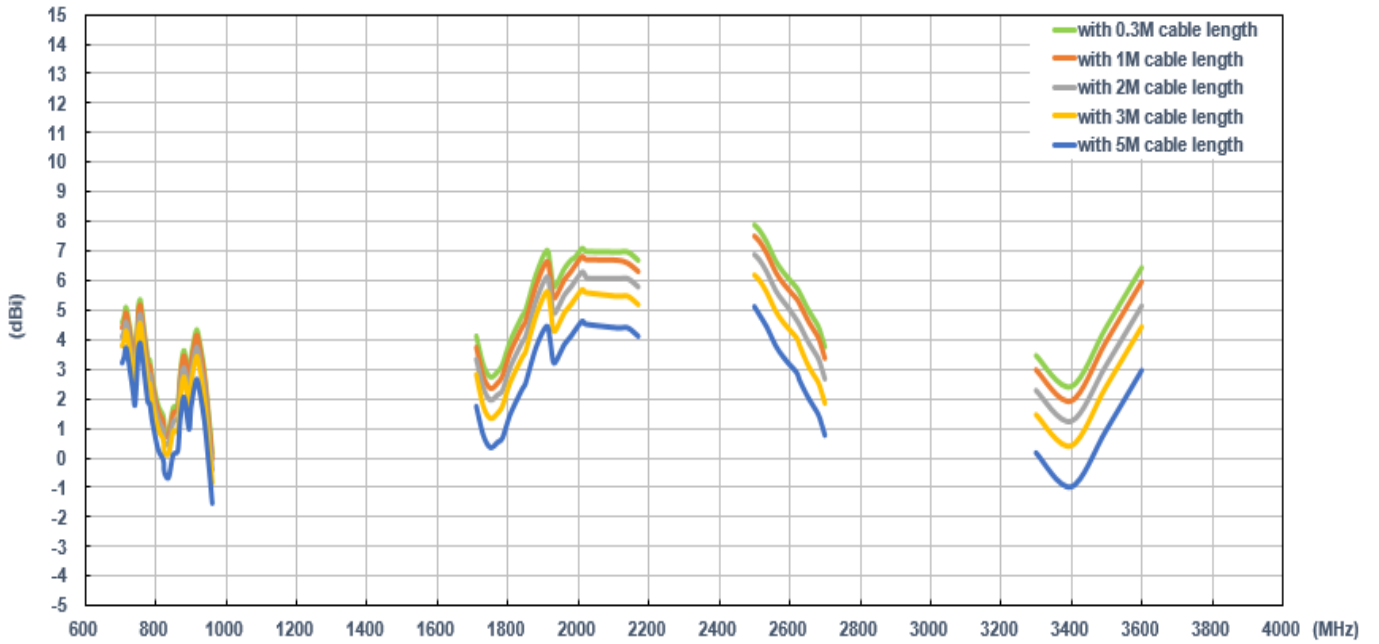

7.1.9 Peak Gain (MIMO_2 on the 50*50cm ground plane)

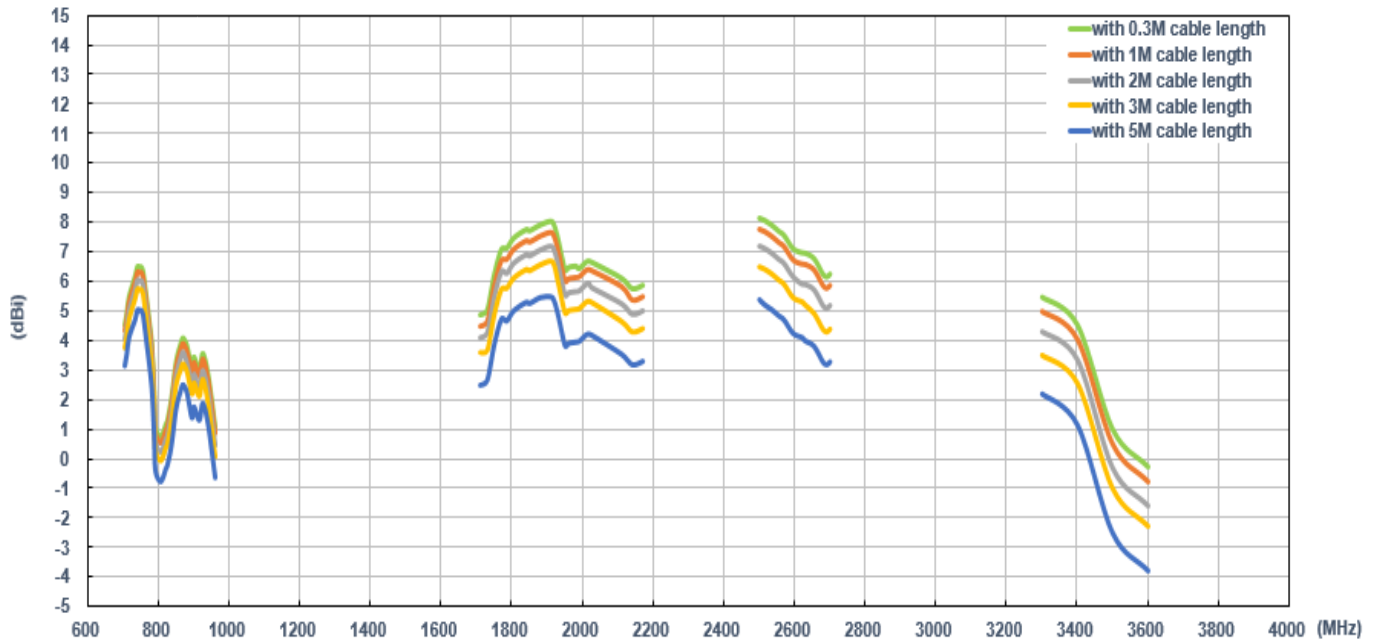

7.2 In free space

7.2.1 Return Loss (MIMO_1 in free space)

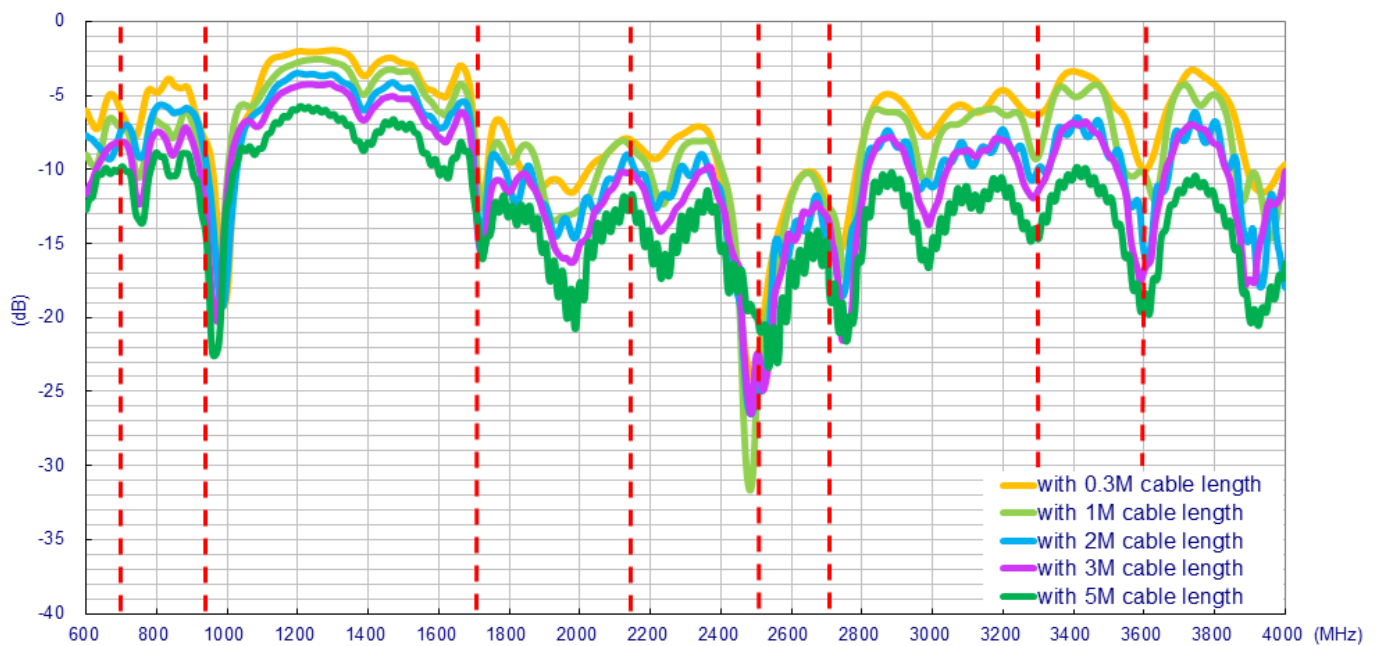

7.2.2 Return Loss (MIMO_2 in free space)

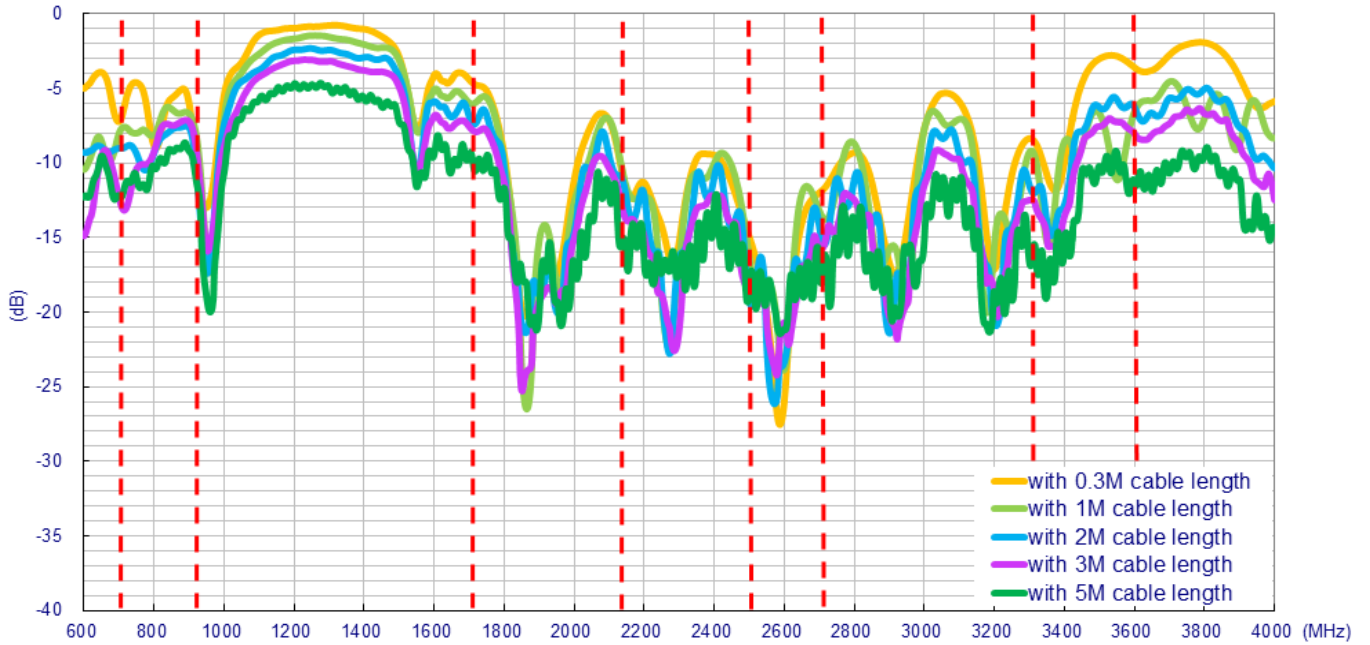

7.2.3 MIMO1 & MIMO2 Isolation (in free space)

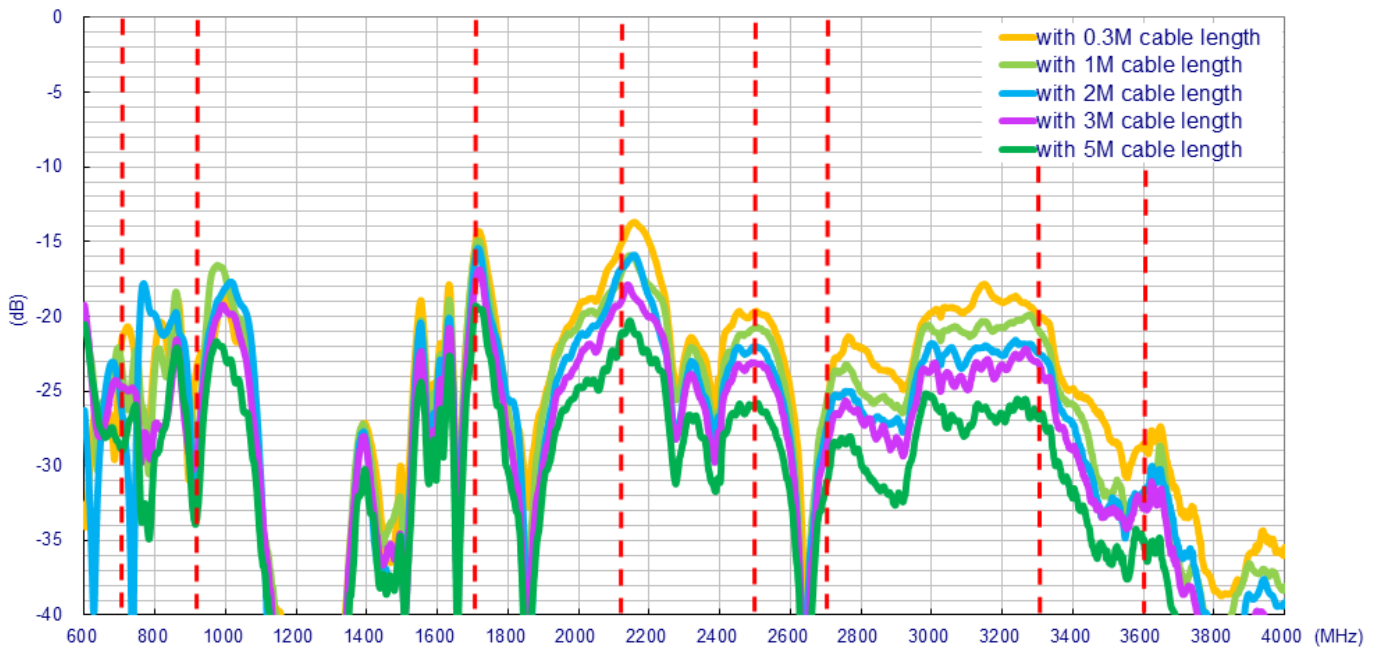

7.2.4 Efficiency (MIMO_1 in free space)

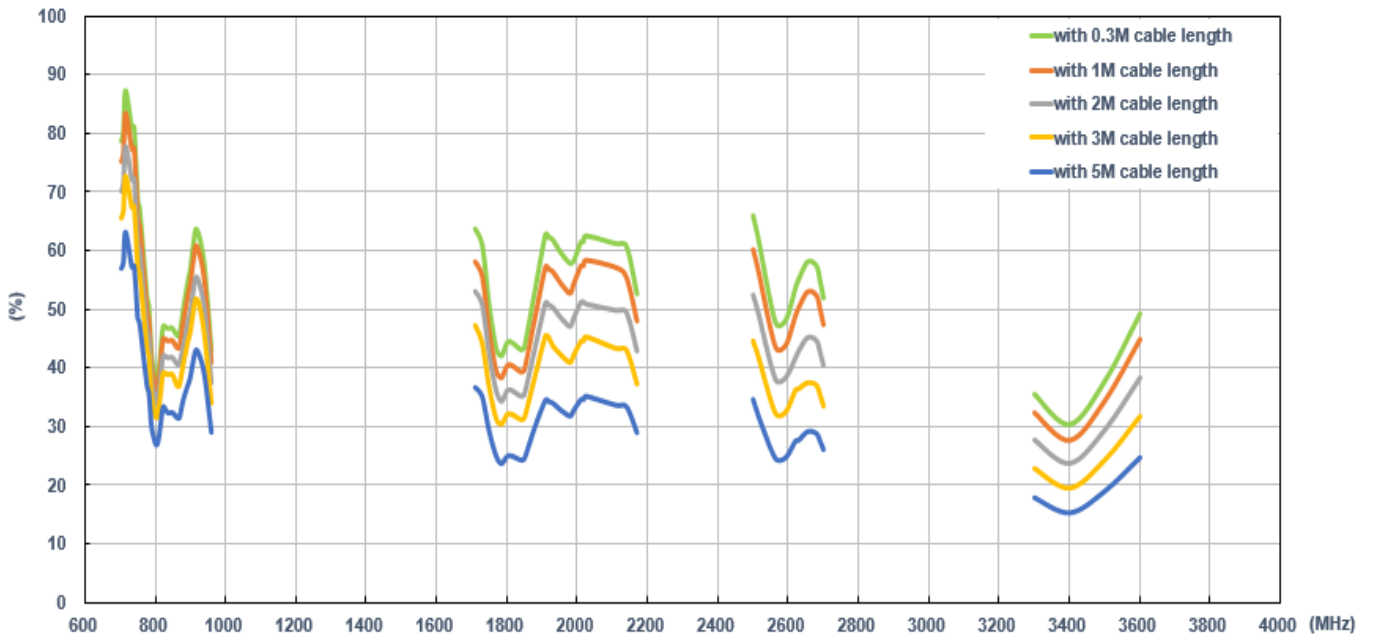

7.2.5 Efficiency (MIMO_2 in free space)

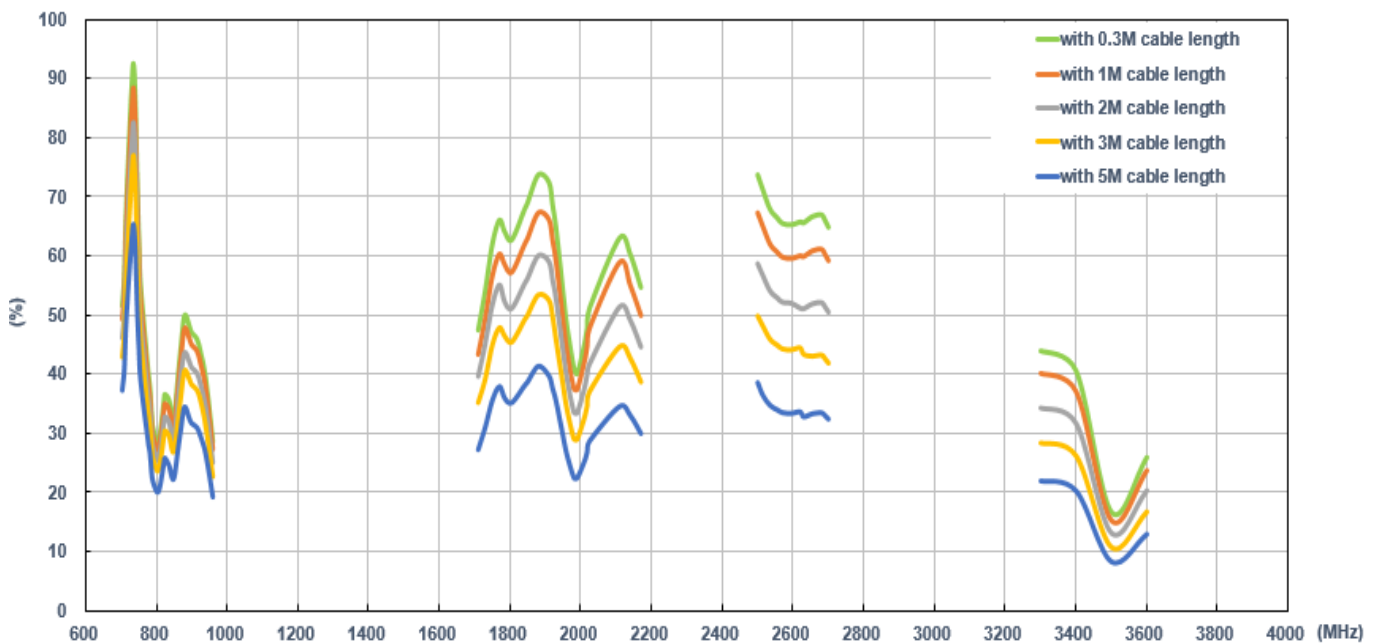

7.2.6 Average Gain (MIMO_1 in free space)

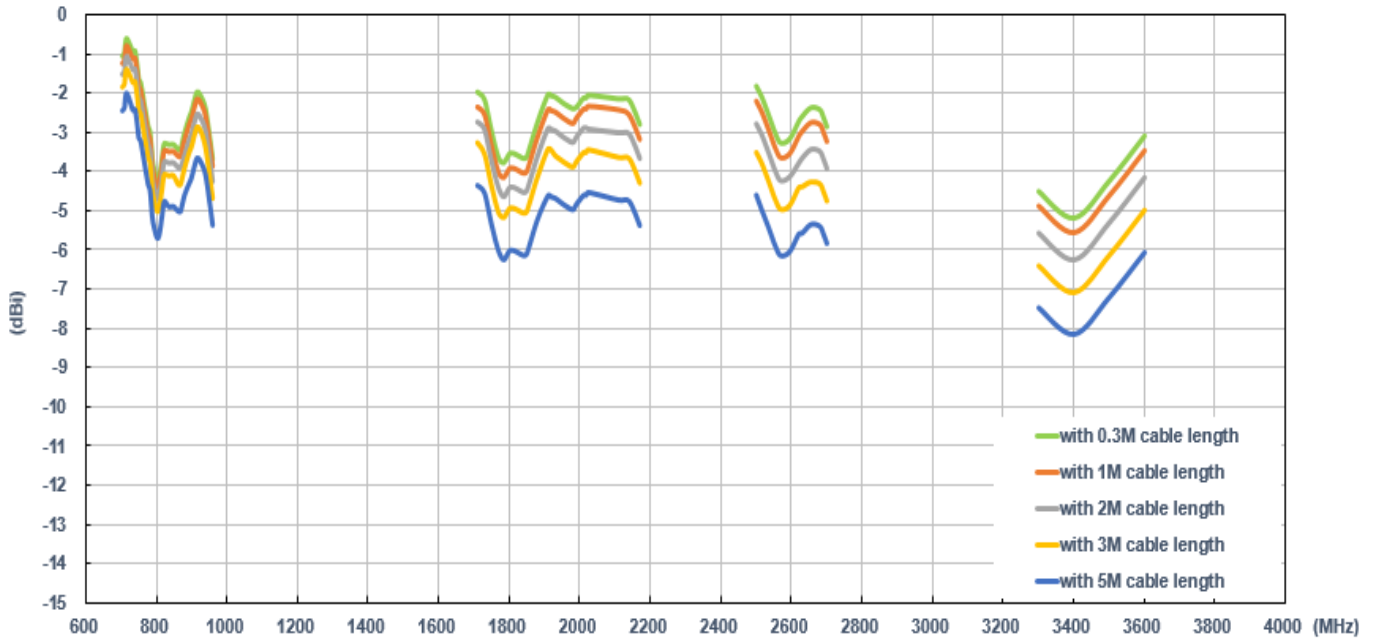

7.2.7 Average Gain (MIMO_2 in free space)

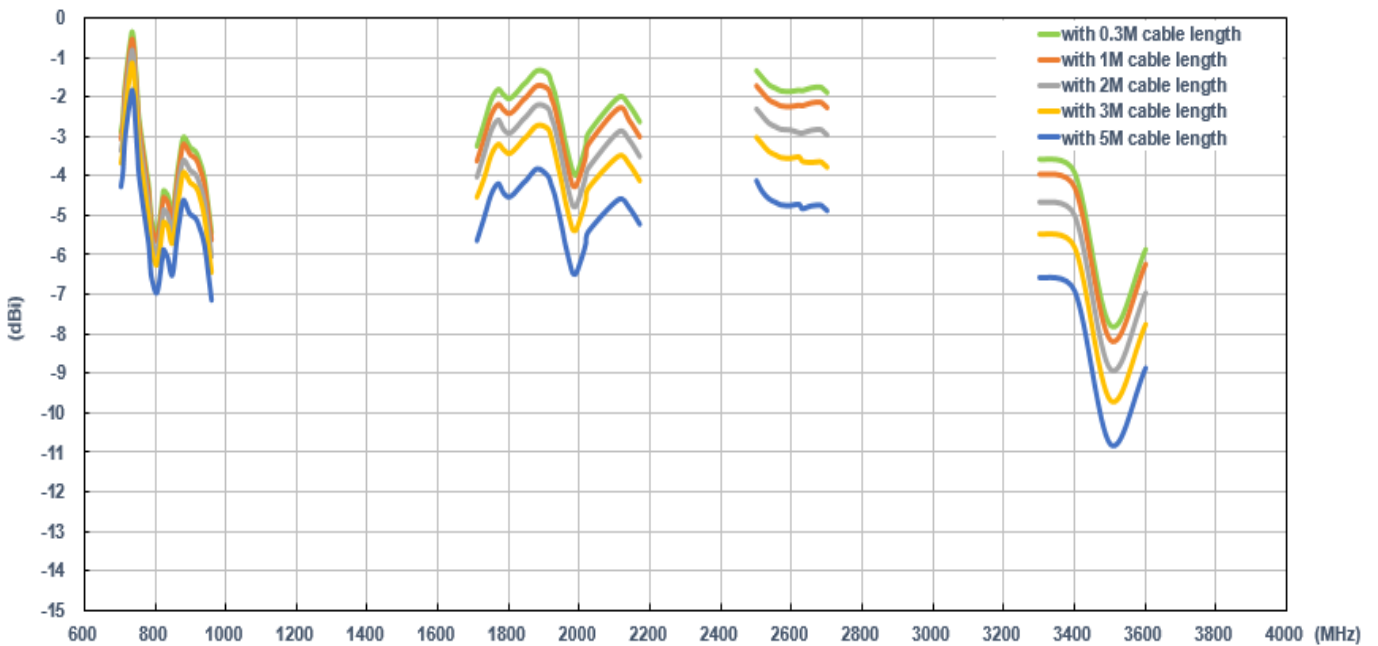

7.2.8 Peak Gain (MIMO_1 in free space)

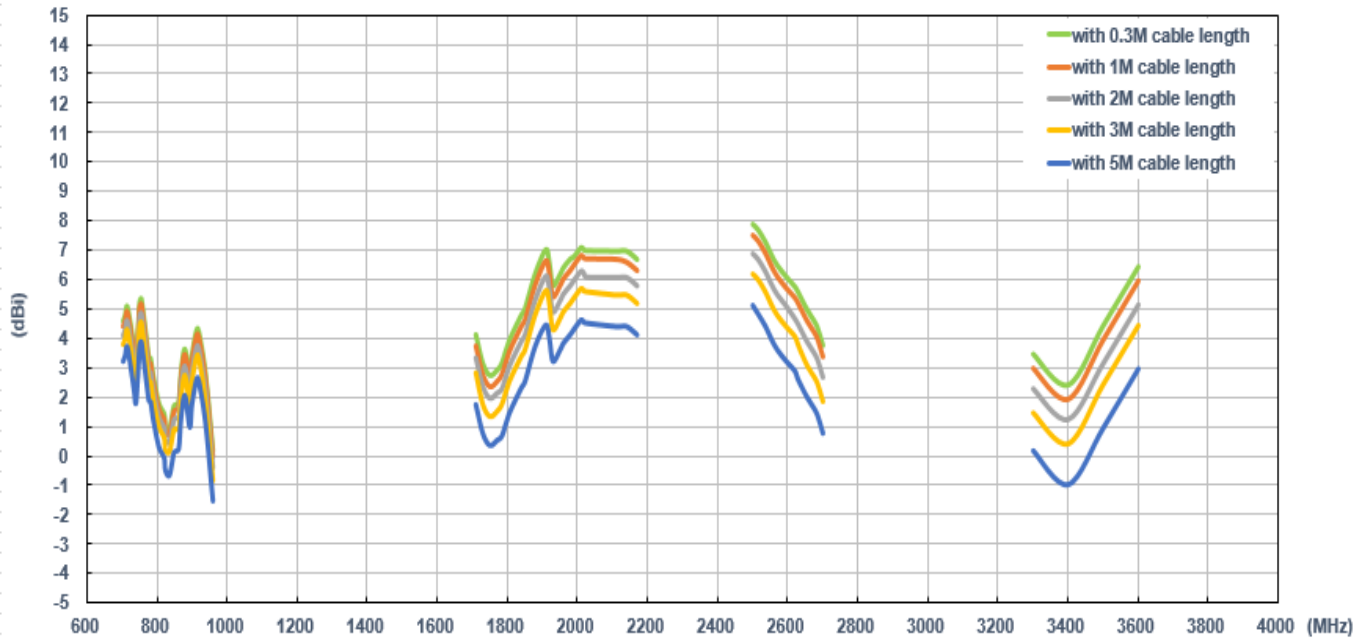

7.2.9 Peak Gain (MIMO_2 in free space)

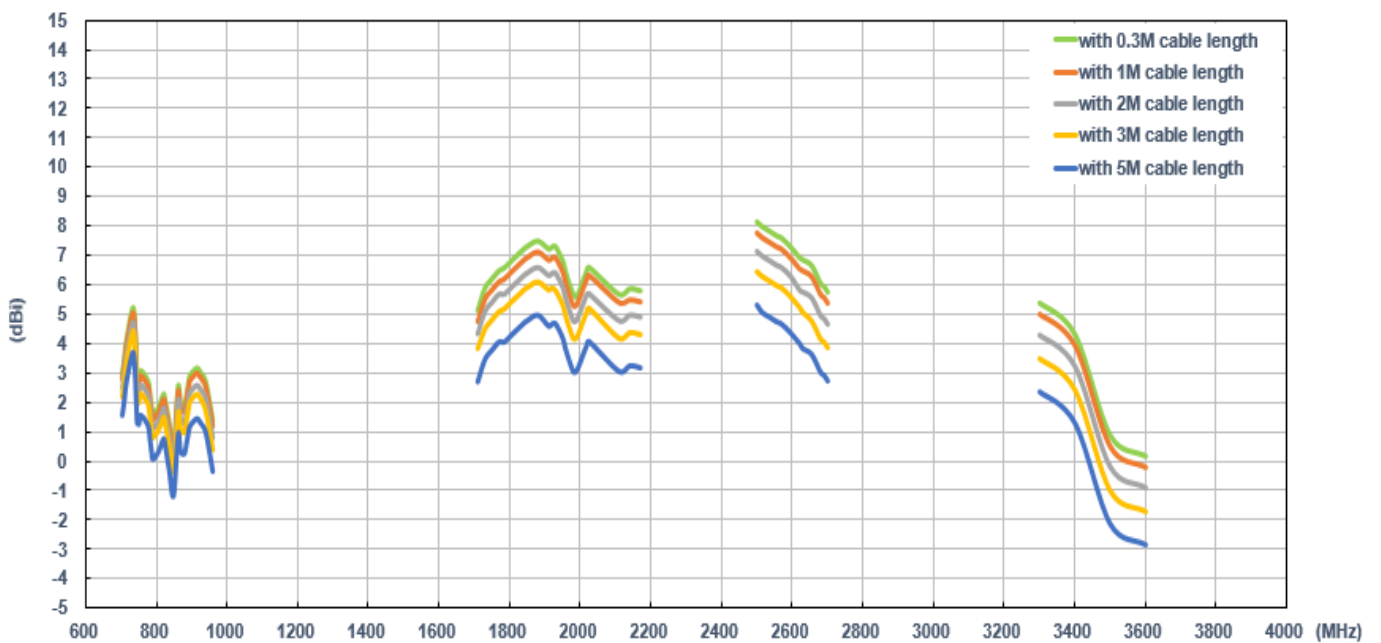

Taoglas makes no warranties based on the accuracy or completeness of the contents of this document and reserves the right to make changes to specifications and product descriptions at any time. Taoglas reserves all rights to this document and the information contained herein.

Reproduction, use or disclosure to third parties without express permission is strictly prohibited.

Copyright © Taoglas